



CUT-OFF MACHINE

QCUT 350 A

The Qcut 350 A is an automatic wet abrasive cut-off machine for samples up to max. Ø 135 mm. Due to its low contact cutting (lcc) function, it gently cuts different types of samples with various geometries, sizes and materials.

The cut-off machine is commonly used in metallography, materialography, mineralogy, as well as for the cutting of composite materials (CFC/PMC/MMC) or electronic devices such as PCB's.

The large cutting chamber and stainless steel table of the machine allow comfortable and flexible operation. A wealth of software based features, such as automatic touch detection, multi-position process and parallel setting of the wheel guard during vertical cutting further enhance the reproducibility of cutting processes.



[Click to view video](#)

PRODUCT ADVANTAGES

- | Automatic horizontal movement
- | Automatic vertical movement
- | Electronic control of cutting force
- | Electronic control of distance
- | Electronic cutting force limiter
- | Memory for saving programs
- | Large range of different clamping tools and systems available
- | Opening on the right for long parts

FEATURES

ELECTRONIC PERFORMANCE CONTROL

The feed rate is reduced upon reaching the preset maximum power. This protects the machine and its cutting components from overloading.

PRECISION CROSS FEED

The optional, automatic cross-feed with series cut function is suitable for exact parallel cuts. Operational handling takes place via electronic control. The electronic cross-feed can also be applied as feeder axis when working with pot wheel.

PULSED CUTTING

In cases where there are heavy sections and materials which are difficult to cut, the variable pulsed cutting system gives decisive advantages.

MULTI-POSITION-PROCESS MPP

With the "Multi-Position-Process" (MPP) you can place multiple specimens on the table and cut them in one sequence. The teach-in function enables a simple and user-friendly setting of various cutting positions.

AUTOMATIC TOUCH DETECTION

After automatic start of the cutting process the sample is approached in rapid run. By touching the cut-off wheel the sample is cut efficiently and safely with preset cutting parameters.

NEW DIMENSIONS

The enlarged cutting chamber and worktable combined with parallel setting of wheel guard increases cutting capacity and travel for all axes. The side door ensures optimum access to the cutting chamber and the additional opening for supplying long sample parts opens up much possibilities.

ELECTRONIC CONTROL

Cutting parameters for the automatic traverse cuts can be saved in the electronic control, and then loaded later. The position of the manual traverse cut is also shown on the display. All parameters such as feed rate, travel and cutting force can be altered during automatic cycles.

CUT-OFF MACHINE QCUT 350 A

SUPERIORITY IN DETAIL

1. Large machine table

- | Axes can be positioned backlash-free
- | Easy grooves for simple mounting of QATM clamping devices
- | T-slots 12 mm for individual clamping devices
- | Max. W x H: 500 mm x 300 mm (without Z-axis), otherwise 400 mm x 300 max.

2. Ergonomic control panel

- | 10,1" color touch display
- | Joystick for manual operation

3. Laser alignment

- | For exact component part positioning before cutting

4. Cut-off wheel lock

- | Simplified cutting disc replacement via locking mechanism and easy nut system

5. Side opening

- | Side opening on the right for long samples

6. Robust housing

- | Sturdy powder-coated aluminum construction

7. Parallel-guided cutting disc cover

- | Increased cutting capacity in cross-cutting



PERFECT CUTTING - CUT-OFF WHEELS FROM QATM

Cutting is more reliable, safe and efficient when processed with the right ingredients: knowledge, care and the right choice of consumables and instruments.



FAST, POWERFUL, FLEXIBLE - QTOOL CLAMPING DEVICES

Our innovative clamping devices are used to clamp workpieces securely and precisely to ensure exact cutting and grinding processes. There is a wide range of different clamping devices that have been developed for specific applications and workpiece sizes.

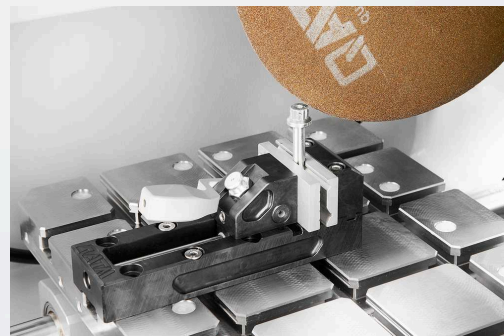

CUT-OFF MACHINE QCUT 350 A

TECHNICAL DATA

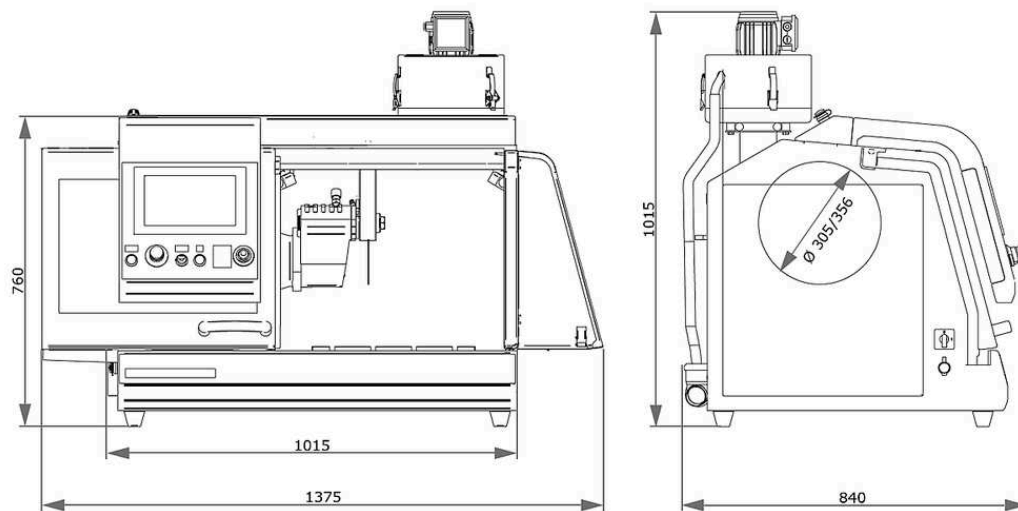

Cutting wheel	up to Ø 356 mm/14"
Max. cutting capacity	Ø 135 mm
Wheel flange size	Ø 32 mm
X-axis automatic	260 mm
Y-axis automatic	175 mm
Z-axis automatic (option)	140 mm
Precision Z-axis	0.1 mm
Table without Z-axis WxD	500 x 300 mm, stainless
Table with Z-axis WxD	400 x 300 mm, stainless
T-slot	12 mm
Speed	variable 800-3400 rpm
Connection power	9.5 kVA
Drive power (main drive)	4 kW S1; 5.5 kW S3
W x H x D	1015 x 760 x 810 mm
Weight	~ 200 kg (depends on equipment)

www.qatm.com/qcut-350-a

ORDER DATA

BASIC EQUIPMENT

MACHINE (ALL ITEMS REQUIRED)

M1821001		Qcut 350 A (Brillant 250) Base machine
----------	---	--

POWER SUPPLY (1 ITEM REQUIRED)

A1821015	Qcut 350 A power supply 400V (3Ph/PE)
A1821016	Qcut 350 A power supply 480V (3Ph/PE)
A1821017	Qcut 350 A power supply 220V (3Ph/PE)





WHEEL GUARD (1 ITEM REQUIRED)

A1821018	Qcut 350 A wheel guard 305mm 12"
A1821019	Qcut 350 A wheel guard 356mm 14"

CROSS FEED (1 ITEM REQUIRED)

A1821020	Qcut 350 A without Z-axis
A1821021	Qcut 350 A manual Z-axis
A1821022	Qcut 350 A automatic Z-axis

RECIRCULATION SYSTEM (1 ITEM REQUIRED)

A5800507		Recirculation cooling System 45L, mobile, with insertion mechanism
A5800508		Recirculation cooling System 45L, mobile, without folding wheels
A6501009		Belt filter 130 - 400V/50Hz (3Ph/PE)
A6501010		Belt filter 130 - 220V/60Hz (3Ph/PE)
Z6501004		Connection set belt filter 130

OPTIONS (TO BE ORDERED WITH MACHINE)

A1821023	Qcut 350 A laser alignment
A1821024	Qcut 350 A centrifugal separator



PRECISION CLAMPING DEVICES, CLAMPING_DEVICES,
PRECISION_CLAMPING_DEVICES

Z1870035	Sample holder L standard Ø 40 mm open, Clamping_devices, Precision_clamping_devices
Z1870037	Sample holder L standard Ø 40 mm closed, Clamping_devices, Precision_clamping_devices
Z1870039	Sample holder L Flex Ø 40 mm, Clamping_devices, Precision_clamping_devices
Z1870043	Sample holder L parallel clamping vice open, Clamping_devices, Precision_clamping_devices
Z1870041	Sample holder L parallel clamping vice closed, Clamping_devices, Precision_clamping_devices
Z1870045	Drop shape sample holder L Ø 40 mm, Clamping_devices, Precision_clamping_devices
Z1870047	Universal clamping vice L, Clamping_devices, Precision_clamping_devices
Z1870049	Matrix clamping vice L, Clamping_devices, Precision_clamping_devices
Z1870054	Mini vice L, Clamping_devices, Precision_clamping_devices
Z1870056	Double parallel vice L, Clamping_devices, Precision_clamping_devices
Z1870058	Adaptor with ball joint L, Clamping_devices, Precision_clamping_devices
Z1870064	Reduction ring Ø 25 mm, Clamping_devices, Precision_clamping_devices
Z1870063	Reduction ring Ø 30 mm, Clamping_devices, Precision_clamping_devices
Z1870071	Reduction ring Ø 40 mm, Clamping_devices, Precision_clamping_devices
Z1870067	Reduction ring 1", Clamping_devices, Precision_clamping_devices
Z1870066	Reduction ring 1 1/4", Clamping_devices, Precision_clamping_devices
Z1870065	Reduction ring 1 1/2", Clamping_devices, Precision_clamping_devices
Z1870068	Manual chuck Ø 32 mm, Clamping_devices, Precision_clamping_devices
Z1870069	Manual chuck Ø 44 mm, Clamping_devices, Precision_clamping_devices
Z1870070	Manual chuck Ø 56 mm, Clamping_devices, Precision_clamping_devices

VACUUM CLAMPING VICES, CLAMPING_DEVICES, PRECISION_CLAMPING_DEVICES

Z1870028	Vacuum sample holder, Clamping_devices, Precision_clamping_devices
01870288	Vacuum holder (sacrificial plate), Clamping_devices, Precision_clamping_devices
Z1304600	Vacuum pump 230V/50Hz for vacuum sample holder, Clamping_devices, Precision_clamping_devices
Z1304634	Vacuum pump 110V/60Hz for vacuum sample holder, Clamping_devices, Precision_clamping_devices

QUICK CLAMPING TOOLS, CLAMPING_DEVICES

QTOOL 60, CLAMPING_DEVICES, QTOOL_SERIES

Z2235200	Qtool 60, Clamping_devices, Qtool_series
02235202	Clamping jaw 32 mm - for Qtool 60, Clamping_devices, Qtool_series
Z2235201	Clamping jaws 60 mm - for Qtool 60, Clamping_devices, Qtool_series
02235212	Clamping jaw 32 mm bevelled - for Qtool 60, Clamping_devices, Qtool_series
02235213	Clamping jaw 32 mm cross prism - for Qtool 60, Clamping_devices, Qtool_series
Z2235202	Clamping jaws 60 mm slotted - for Qtool 60, Clamping_devices, Qtool_series
Z2235203	Clamping jaws 60 mm slotted prism - for Qtool 60, Clamping_devices, Qtool_series

QTOOL 80, CLAMPING_DEVICES, QTOOL_SERIES

Z2231203	Qtool 80 - 100mm, Clamping_devices, Qtool_series
02231243	Clamping jaw 40 mm, Clamping_devices, Qtool_series
Z2231215	Clamping jaws 70 mm, Clamping_devices, Qtool_series
02231245	Clamping jaw 40 mm bevelled, Clamping_devices, Qtool_series
02231246	Clamping jaw 40 mm cross prism, Clamping_devices, Qtool_series
Z2231216	Clamping jaws 70 mm slotted, Clamping_devices, Qtool_series
Z2231217	Clamping jaws 70 mm slotted prism, Clamping_devices, Qtool_series

QTOOL 80 VARIO, CLAMPING_DEVICES, QTOOL_SERIES

Z2231200	Qtool 80 Vario - 100 mm, Clamping_devices, Qtool_series
Z2231210	Workpiece stop, Clamping_devices, Qtool_series

02231200	Clamping jaw, 40 mm - for Qtool 80 Vario, Clamping_devices, Qtool_series
Z2231211	Clamping jaws, 70 mm, Clamping_devices, Qtool_series
02231213	Prism jaw, 40 mm, Clamping_devices, Qtool_series
02231229	Bevelled jaw, 40 mm, Clamping_devices, Qtool_series
02231230	Cross prism jaw, 40 mm, Clamping_devices, Qtool_series
Z2231212	Round bar jaws, 70 mm slotted, Clamping_devices, Qtool_series
Z2231213	Prism jaws, 70 mm slotted, Clamping_devices, Qtool_series
Z2231214	Clamping jaws, 70 mm slotted, Clamping_devices, Qtool_series

EASY-CLAMPING PLATES, CLAMPING_DEVICES, EASY_CLAMPING_PLATES

Z2236030	Easy-clamping plate S, Clamping_devices, Easy_clamping_plates
Z2236031	Easy-clamping plate S with rotating unit, Clamping_devices, Easy_clamping_plates
Z2236035	Easy-clamping plate M, Clamping_devices, Easy_clamping_plates

ACCESSORIES FOR EASY-CLAMPING PLATES

Z2236032	Easy adaption horizontal, Clamping_devices, Easy_clamping_plates
Z2236033	Easy adaption vertical, Clamping_devices, Easy_clamping_plates
Z2236034	Easy adaption Qtool 40 - 60, Clamping_devices, Easy_clamping_plates
Z2236038	Multitower rotating plate, Clamping_devices, Easy_clamping_plates
Z2236039	Multitower, Clamping_devices, Easy_clamping_plates
Z2236040	Swivel unit Qtool 40 - 60, Clamping_devices, Easy_clamping_plates
Z2236036	Easy-multifunctional plate, Clamping_devices, Easy_clamping_plates

CLAMPING ACCESSORIES FOR ROTATING, SWIVELING AND SPECIAL APPLICATIONS, CLAMPING_DEVICES, CLAMPING_ACCESSORIES_SPECIALS

Z2236041	Swivel unit Qtool 60 - 80, Clamping_devices, Clamping_accessories_specials
Z1304643	Screw clamber with Easy-clamping plate M, Clamping_devices, Clamping_accessories_specials
Z1304636	Expansion clamping device, Clamping_devices, Clamping_accessories_specials

Z2236009	Vertical clamp single, Clamping_devices, Clamping_accessories_specials
Z2236010	Vertical clamp double, Clamping_devices, Clamping_accessories_specials
Z2234010	Clamping system X-Clamp 3858, Clamping_devices, Clamping_accessories_specials

CROSS VICES, CLAMPING_DEVICES, CLAMPING_ACCESSORIES_SPECIALS

Z1340010	 Cross vice 50 - 100, Clamping_devices, Clamping_accessories_specials
----------	--





ANGLE AND ROTATING VICES, CLAMPING_DEVICES, CLAMPING_ACCESSORIES_SPECIALS



Z1304001	Angle vice 60, Clamping_devices, Clamping_accessories_specials
01304008	Prism jaw angle vice 60, Clamping_devices, Clamping_accessories_specials

ROTATING DEVICES, CLAMPING_DEVICES, ROTATION_DEVICES

Z1870059	Rotation device type RD1, Clamping_devices, Rotation_devices
Z1891001	Rotation device type RD2.1, Clamping_devices, Rotation_devices

UNIVERSAL VICES AND ACCESSORIES, CLAMPING_DEVICES, UNIVERSAL_VICES_AND_ACCESSORIES

Z1350025	Clamping rail, Clamping_devices, Universal_vices_and_accessories
01350022	Prism 120°, Clamping_devices, Universal_vices_and_accessories
01350023	Prism slim, Clamping_devices, Universal_vices_and_accessories
01350024	Prism 90°, Clamping_devices, Universal_vices_and_accessories
01350025	Prism 90° high, Clamping_devices, Universal_vices_and_accessories
Z1350008	 Universal vice Piccolo 54, Clamping_devices, Universal_vices_and_accessories
Z1350010	 Suitcase set universal vice Piccolo 54, Clamping_devices, Universal_vices_and_accessories
Z1350012	 Universal vice Piccolo 100, Clamping_devices, Universal_vices_and_accessories
Z1350002	 Universal vice Mono 61, Clamping_devices, Universal_vices_and_accessories

Z1350004		Suitcase set universal vice Mono 61, Clamping_devices, Universal_vices_and_accessories
Z1350011		Universal vice Mono 132, Clamping_devices, Universal_vices_and_accessories
Z1350005		Universal vice Duo, Clamping_devices, Universal_vices_and_accessories
Z1350006		Chain vice set, Clamping_devices, Universal_vices_and_accessories
92005796		Longitudinal v-shoe, Clamping_devices, Universal_vices_and_accessories
92005797		Traverse v-shoe, Clamping_devices, Universal_vices_and_accessories
92005799		Longitudinal bridge, Clamping_devices, Universal_vices_and_accessories
92005800		Traverse bridge, Clamping_devices, Universal_vices_and_accessories
92005798		Standard clamping shoe, Clamping_devices, Universal_vices_and_accessories
Z1350007		Height adapter 60mm Piccolo, Clamping_devices, Universal_vices_and_accessories
Z1350003		Height adapter 74mm Mono, Clamping_devices, Universal_vices_and_accessories
95003172		Clamping arm extension Piccolo 54 and Mono 61, Clamping_devices, Universal_vices_and_accessories
Z1304591		Fixing screw M6 x 25, Clamping_devices, Universal_vices_and_accessories
95003169		Fixing screw Piccolo M8 x 25, Clamping_devices, Universal_vices_and_accessories
95003170		Fixing screw Piccolo M10 x 25, Clamping_devices, Universal_vices_and_accessories
95003168		Fixing screw Mono M10 x 32, Clamping_devices, Universal_vices_and_accessories
91001157		T-slot nut - stainless M6 x 8, Clamping_devices, Universal_vices_and_accessories
91001161		T-slot nut - stainless M8 x 10, Clamping_devices, Universal_vices_and_accessories
91001159		T-slot nut - stainless M8 x 12, Clamping_devices, Universal_vices_and_accessories
91001158		T-slot nut - stainless M10 x 12, Clamping_devices, Universal_vices_and_accessories