



CUT-OFF MACHINE

QCUT 250 M

The Qcut 250 M is an especially user-friendly wet abrasive cutting machine with manual cut-off. Opening the machine folds away the hood to the inside so that the whole cutting chamber is easily accessible. The round window opens a wide field of view during the cutting process.

The cutting wheel cooling is integrated directly into the wheel guarding cover. The large, stainless table is equipped with replaceable wearing plates. Transverse grooves allow optimized alignment of clamping vices (e. g. clamping vice 80).

PRODUCT ADVANTAGES

- | Manual vertical movement
- | Large cutting chamber
- | Opening on left- and righthand side for continuous long parts
- | Large table with exchangeable wearing plates
- | Hood covering complete width for optimal accessibility
- | Easy operation
- | Large range of different clamping tools and systems available
- | Current safety standard with door interlocking system
- | Solid aluminium case construction, powder coated

FEATURES

FINE DYNAMIC CUT-OFF

The manual cutting movement of the Y-axis is executed precisely and jerk-free via lever. Length and angle of the lever are adjustable. Further, the cutting depth can easily be adjusted by using a limiter.

ILLUMINATION

Through the large rounded window, the cutting chamber is comfortably visible. For direct lighting, the Qcut 250 M can be equipped with a flexible LED light.

SAFETY

The integrated standstill monitoring allows opening only when the cutting wheel is not rotating.

PERFECT CUTTING - CUT-OFF WHEELS FROM QATM

Cutting is more reliable, safe and efficient when processed with the right ingredients: knowledge, care and the right choice of consumables and instruments.



FAST, POWERFUL, FLEXIBLE - QTOOL CLAMPING DEVICES

Our innovative clamping devices are used to clamp workpieces securely and precisely to ensure exact cutting and grinding processes. There is a wide range of different clamping devices that have been developed for specific applications and workpiece sizes.

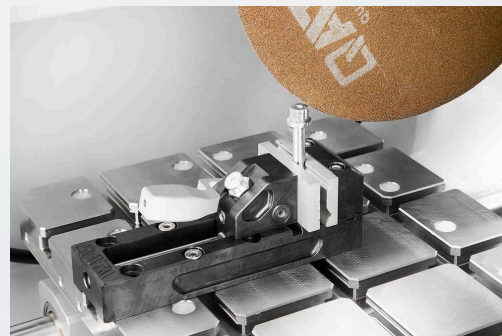

CUT-OFF MACHINE QCUT 250 M

TECHNICAL DATA

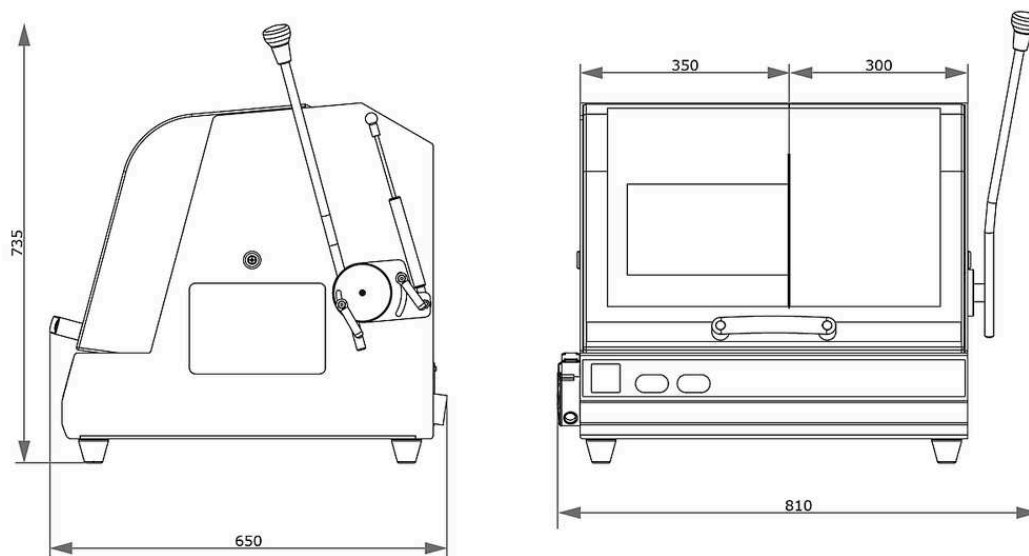

Cutting wheel	up to \varnothing 250 mm/10"
Max. cutting capacity	\varnothing 55 mm / \varnothing 90 mm (up to 25 mm length)
Wheel flange size	\varnothing 32 mm
Y-axis (vertical movement)	145 mm
Table WxD	350 x 288 mm stainless
T-slot	12 mm
Connection power	4.5 kVA
Drive power (main drive)	3 kW S6 40%
W x H x D	810 x 735 x 650 mm
Weight	~ 75 kg

www.qatm.com/qcut-250-m

ORDER DATA

BASIC EQUIPMENT







MACHINE (ALL ITEMS REQUIRED)

M1880000		Qcut 250 M (Brillant 200) Base machine
----------	---	--



POWER SUPPLY (1 ITEM REQUIRED)

A1880000	Qcut 250 M power supply 400V/50Hz (3Ph/N/PE)
A1880001	Qcut 250 M power supply 480V/60Hz (3/PE)
A1880002	Qcut 250 M power supply 220V/60Hz (3/PE)

RECIRCULATION SYSTEM (1 ITEM REQUIRED)

A5800484		Recirculation Cooling System 45L 400V/50Hz (3Ph/PE) mobile, with insertion mechanism
A5800485		Recirculation Cooling System 45L 480V/60Hz (3Ph/PE) mobile, with insertion mechanism
A5800486		Recirculation Cooling System 45L 220V/60Hz (3Ph/PE) mobile, with insertion mechanism
A5800487		Recirculation Cooling System 45L 400V/50Hz (3Ph/PE) mobile, without folding wheels
A5800488		Recirculation Cooling System 45L 480V/60Hz (3Ph/PE) mobile, without folding wheels
A5800489		Recirculation Cooling System 45L 220V/60Hz (3Ph/PE) mobile, without folding wheels

OPTIONS (TO BE ORDERED WITH MACHINE)

Z1820009		Centrifugal separator (machine mounted) 400V/50Hz/3 Ph
Z1820012		Centrifugal separator (machine mounted) 480V/60Hz/3 Ph

Z1820011



Centrifugal separator (machine mounted) 220V/60Hz/3 Ph

PRECISION CLAMPING DEVICES, CLAMPING_DEVICES, PRECISION_CLAMPING_DEVICES

Z1870035	Sample holder L standard Ø 40 mm open, Clamping_devices, Precision_clamping_devices
Z1870037	Sample holder L standard Ø 40 mm closed, Clamping_devices, Precision_clamping_devices
Z1870039	Sample holder L Flex Ø 40 mm, Clamping_devices, Precision_clamping_devices
Z1870043	Sample holder L parallel clamping vice open, Clamping_devices, Precision_clamping_devices
Z1870041	Sample holder L parallel clamping vice closed, Clamping_devices, Precision_clamping_devices
Z1870045	Drop shape sample holder L Ø 40 mm, Clamping_devices, Precision_clamping_devices
Z1870047	Universal clamping vice L, Clamping_devices, Precision_clamping_devices
Z1870049	Matrix clamping vice L, Clamping_devices, Precision_clamping_devices
Z1870054	Mini vice L, Clamping_devices, Precision_clamping_devices
Z1870056	Double parallel vice L, Clamping_devices, Precision_clamping_devices
Z1870058	Adaptor with ball joint L, Clamping_devices, Precision_clamping_devices
Z1870063	Reduction ring Ø 30 mm, Clamping_devices, Precision_clamping_devices
Z1870071	Reduction ring Ø 40 mm, Clamping_devices, Precision_clamping_devices
Z1870067	Reduction ring 1", Clamping_devices, Precision_clamping_devices
Z1870066	Reduction ring 1 1/4", Clamping_devices, Precision_clamping_devices
Z1870065	Reduction ring 1 1/2", Clamping_devices, Precision_clamping_devices
Z1870069	Manual chuck Ø 44 mm, Clamping_devices, Precision_clamping_devices
Z1870070	Manual chuck Ø 56 mm, Clamping_devices, Precision_clamping_devices

VACUUM CLAMPING VICES, CLAMPING_DEVICES, PRECISION_CLAMPING_DEVICES

Z1870028	Vacuum sample holder, Clamping_devices, Precision_clamping_devices
01870288	Vacuum holder (sacrificial plate), Clamping_devices, Precision_clamping_devices

Z1304600	Vacuum pump 230V/50Hz for vacuum sample holder, Clamping_devices, Precision_clamping_devices
Z1304634	Vacuum pump 110V/60Hz for vacuum sample holder, Clamping_devices, Precision_clamping_devices

QUICK CLAMPING TOOLS, CLAMPING_DEVICES

QTOOL 60, CLAMPING_DEVICES, QTOOL_SERIES

Z2235200	Qtool 60, Clamping_devices, Qtool_series
02235202	Clamping jaw 32 mm - for Qtool 60, Clamping_devices, Qtool_series
Z2235201	Clamping jaws 60 mm - for Qtool 60, Clamping_devices, Qtool_series
02235212	Clamping jaw 32 mm bevelled - for Qtool 60, Clamping_devices, Qtool_series
02235213	Clamping jaw 32 mm cross prism - for Qtool 60, Clamping_devices, Qtool_series
Z2235202	Clamping jaws 60 mm slotted - for Qtool 60, Clamping_devices, Qtool_series
Z2235203	Clamping jaws 60 mm slotted prism - for Qtool 60, Clamping_devices, Qtool_series

QTOOL 80, CLAMPING_DEVICES, QTOOL_SERIES

Z2231203	Qtool 80 - 100mm, Clamping_devices, Qtool_series
02231243	Clamping jaw 40 mm, Clamping_devices, Qtool_series
Z2231215	Clamping jaws 70 mm, Clamping_devices, Qtool_series
02231245	Clamping jaw 40 mm bevelled, Clamping_devices, Qtool_series
02231246	Clamping jaw 40 mm cross prism, Clamping_devices, Qtool_series
Z2231216	Clamping jaws 70 mm slotted, Clamping_devices, Qtool_series
Z2231217	Clamping jaws 70 mm slotted prism, Clamping_devices, Qtool_series

QTOOL 80 VARIO, CLAMPING_DEVICES, QTOOL_SERIES

Z2231200	Qtool 80 Vario - 100 mm, Clamping_devices, Qtool_series
Z2231210	Workpiece stop, Clamping_devices, Qtool_series
02231200	Clamping jaw, 40 mm - for Qtool 80 Vario, Clamping_devices, Qtool_series
Z2231211	Clamping jaws, 70 mm, Clamping_devices, Qtool_series
02231213	Prism jaw, 40 mm, Clamping_devices, Qtool_series
02231229	Bevelled jaw, 40 mm, Clamping_devices, Qtool_series

02231230	Cross prism jaw, 40 mm, Clamping_devices, Qtool_series
Z2231212	Round bar jaws, 70 mm slotted, Clamping_devices, Qtool_series
Z2231213	Prism jaws, 70 mm slotted, Clamping_devices, Qtool_series
Z2231214	Clamping jaws, 70 mm slotted, Clamping_devices, Qtool_series

EASY-CLAMPING PLATES, CLAMPING_DEVICES, EASY_CLAMPING_PLATES

ACCESSORIES FOR EASY-CLAMPING PLATES

Z2236032	Easy adaption horizontal, Clamping_devices, Easy_clamping_plates
Z2236033	Easy adaption vertical, Clamping_devices, Easy_clamping_plates
Z2236034	Easy adaption Qtool 40 - 60, Clamping_devices, Easy_clamping_plates
Z2236038	Multitower rotating plate, Clamping_devices, Easy_clamping_plates
Z2236039	Multitower, Clamping_devices, Easy_clamping_plates
Z2236040	Swivel unit Qtool 40 - 60, Clamping_devices, Easy_clamping_plates
Z2236036	Easy-multifunctional plate, Clamping_devices, Easy_clamping_plates







CLAMPING ACCESSORIES FOR ROTATING, SWIVELING AND SPECIAL APPLICATIONS, CLAMPING_DEVICES, CLAMPING_ACCESSORIES_SPECIALS

Z2236041	Swivel unit Qtool 60 - 80, Clamping_devices, Clamping_accessories_specials
Z1304643	Screw clammer with Easy-clamping plate M, Clamping_devices, Clamping_accessories_specials
Z1304636	Expansion clamping device, Clamping_devices, Clamping_accessories_specials
Z2236009	Vertical clamp single, Clamping_devices, Clamping_accessories_specials
Z2236010	Vertical clamp double, Clamping_devices, Clamping_accessories_specials
Z2234010	Clamping system X-Clamp 3858, Clamping_devices, Clamping_accessories_specials

CROSS VICES, CLAMPING_DEVICES, CLAMPING_ACCESSORIES_SPECIALS

Z1340010	 Cross vice 50 - 100, Clamping_devices, Clamping_accessories_specials
----------	--

UNIVERSAL VICES AND ACCESSORIES, CLAMPING_DEVICES, UNIVERSAL_VICES_AND_ACCESSORIES

01350022		Prism 120°, Clamping_devices, Universal_vices_and_accessories
01350023		Prism slim, Clamping_devices, Universal_vices_and_accessories
01350024		Prism 90°, Clamping_devices, Universal_vices_and_accessories
01350025		Prism 90° high, Clamping_devices, Universal_vices_and_accessories
Z1350008		Universal vice Piccolo 54, Clamping_devices, Universal_vices_and_accessories
Z1350010		Suitcase set universal vice Piccolo 54, Clamping_devices, Universal_vices_and_accessories
Z1350012		Universal vice Piccolo 100, Clamping_devices, Universal_vices_and_accessories
Z1350002		Universal vice Mono 61, Clamping_devices, Universal_vices_and_accessories
Z1350004		Suitcase set universal vice Mono 61, Clamping_devices, Universal_vices_and_accessories
Z1350011		Universal vice Mono 132, Clamping_devices, Universal_vices_and_accessories
Z1350005		Universal vice Duo, Clamping_devices, Universal_vices_and_accessories
Z1350006		Chain vice set, Clamping_devices, Universal_vices_and_accessories
92005796		Longitudinal v-shoe, Clamping_devices, Universal_vices_and_accessories
92005797		Traverse v-shoe, Clamping_devices, Universal_vices_and_accessories
92005799		Longitudinal bridge, Clamping_devices, Universal_vices_and_accessories
92005800		Traverse bridge, Clamping_devices, Universal_vices_and_accessories
92005798		Standard clamping shoe, Clamping_devices, Universal_vices_and_accessories
Z1350007		Height adapter 60mm Piccolo, Clamping_devices, Universal_vices_and_accessories
Z1350003		Height adapter 74mm Mono, Clamping_devices, Universal_vices_and_accessories
95003172		Clamping arm extension Piccolo 54 and Mono 61, Clamping_devices, Universal_vices_and_accessories
Z1304591		Fixing screw M6 x 25, Clamping_devices, Universal_vices_and_accessories
95003169		Fixing screw Piccolo M8 x 25, Clamping_devices, Universal_vices_and_accessories

95003170	Fixing screw Piccolo M10 x 25, Clamping_devices, Universal_vices_and_accessories
95003168	Fixing screw Mono M10 x 32, Clamping_devices, Universal_vices_and_accessories
91001157	T-slot nut - stainless M6 x 8, Clamping_devices, Universal_vices_and_accessories
91001161	T-slot nut - stainless M8 x 10, Clamping_devices, Universal_vices_and_accessories
91001159	T-slot nut - stainless M8 x 12, Clamping_devices, Universal_vices_and_accessories
91001158	T-slot nut - stainless M10 x 12, Clamping_devices, Universal_vices_and_accessories