



CUTTING ROBOT

QCUT 600 BOT

CUTTING ROBOT QCUT 600 BOT
SUPERIORITY IN DETAIL

1. Ergonomic control panel

- | Large 12.1" industrial touchscreen with intuitive QATM software
- | Quick setup, control of all axes with two joysticks
- | The sliding control panel enables unobstructed working conditions

2. Robust machine body

- | Sturdy powder-coated steel construction
- | Integrable recirculating cooling unit
- | Automatic central lubrication of the axes

3. Large round machine table

- | Made of stainless steel with integrated longitudinal and cross T-slots

5. Optimized swivel arm

- | Highly efficient cooling system
- | Increased cutting capacity thanks to parallel guided cut-off wheel guard
- | Laser alignment aid for easy workpiece positioning

6. Rotation axis, B-axis

- | Rotation range 360°, with combined C-axis 200°
- | Positioning accuracy: $\pm 0.1^\circ$

7. Optional rotation axis, C-axis

- | Rotation range: max. 360°
- | Removable modular rotation axis
- | Clamping capabilities can be expanded with a lathe chuck or other clamping devices



FREE ACCESSIBILITY

FOR LARGE WORKPIECES

Large workpieces can be placed directly on the machine table by a forklift or crane via the wide sliding door.



CUTTING ROBOT QCUT 600 BOT

IN 5 DIMENSIONS, SECTIONING THE SMALL FROM THE LARGE

With the patented 5-axis technology, workpieces can be cut at any angle precisely, repeatably, quickly, and easily. All axes are finely adjustable and remain vibration-free during the cut-off process – precise work is easier than ever. The positioning capabilities/movement of the various axes in combination with the clamping systems enables precise cutting of the workpiece without time-consuming re-clamping of the workpiece. All necessary cut-offs can be performed sequentially and automatically – even with large workpieces.

1. Y-AXIS (Chop cut)

- | Cutting range: 360 mm, automatic
- | Rapid traverse up to 80 mm/s.

2. Z-AXIS (Cross feed)

- | Travel: 550 mm, automatic
- | Cross feed for precise parallel cuts in series

3. B-AXIS (Rotation axis)

- | Rotation range: max. 360°, with combined C-axis 200°, automatic
- | Positioning accuracy: $\pm 0.1^\circ$

4. X-AXIS (Travel cut)

- | Cutting range: 550 mm, automatic
- | Rapid traverse up to 80 mm/s.

5. C-AXIS (Rotation axis)

- | Rotation range: max. 360°, automatic
- | Removeable modular rotation axis

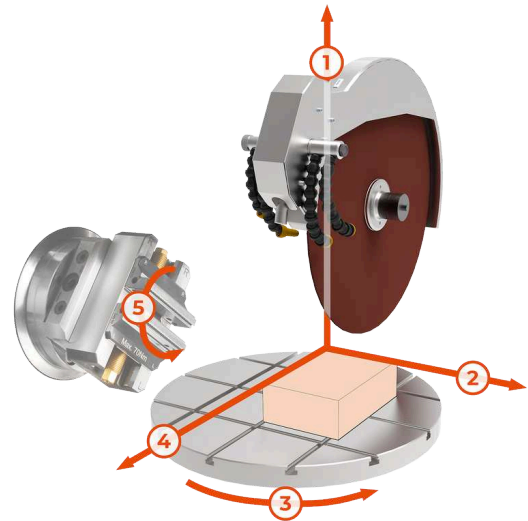

CUTTING ROBOT QCUT 600 BOT

FEATURES



STAINLESS STEEL ROTARY TABLE

Spacious rotary table (Ø 600 mm) enables precise work even under heavy loads.

- | Rotation of the machine table (max. 360°) eliminates the need for time-consuming re-clamping of workpieces
- | Can be expanded with a modular adaptable rotation axis (C-axis)
- | Integrated T-slots for the Easy clamping system for quick mounting of clamping tools



AUTOMATIC CUT-OFF WHEEL MEASUREMENT

Dynamic cut-off wheel measurement leads to reproducible cutting results with consistent quality.

- | Automatic monitoring of the current cut-off wheel diameter
- | Adjustment of cutting parameters after each cut
- | Enables consistent cutting speed and cutting depth



ROBUST MACHINE WITH LARGE CUTTING CHAMBER

Robust, powder-coated steel machine body with large sliding door made of scratch-resistant laminated safety glass and large side door.

- | Machine body with integrable recirculating cooling unit and automatic central lubrication
- | Optimal access to the large cutting chamber with safety interlock that prevents door opening when the cut-off wheel is operating
- | Large side door for easy cut-off wheel replacement



CUTTING OPTIMIZATION

To optimize the cutting quality, the machine automatically detects local material characteristics, such as hardened areas.

- | Cutting force-dependent feed control
- | Cut detection: When starting a new cut, the workpiece is automatically detected and approached at reduced speed
- | Parallel-guided cut-off wheel guard increases the cutting capacity of the cut-off wheel during chop cuts

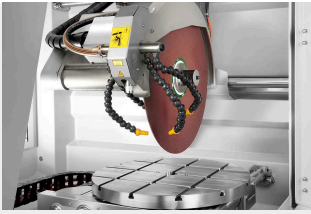

POWERFUL CUT-OFF WHEEL DRIVE

Precise swivel arm guidance and cut-off wheel cooling.

- | Water-cooled main drive with 15 kW drive power
- | Optimal cooling thanks to flexibly adjustable cooling hoses
- | Parallel guided cut-off wheel guard for increased cutting capacity when making cross cuts



INTUITIVE AND EASY OPERATION

Large 12.1" industrial touchscreen with intuitive QATM user software, joysticks, and emergency stop switch.

- | The teach function enables user-friendly programming of cutting positions by manually positioning the machine at each desired location
- | Simultaneous positioning and automatic cutting of different workpieces without re-clamping (Multi-Position Process MPP)

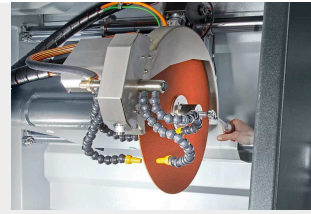

CLEVER DESIGN

Easy cut-off wheel replacement and simple clamping allow you to focus on cutting.

- | Laser alignment for easy workpiece positioning
- | Power clamping nut: easy clamping and loosening of the cut-off wheel



MAXIMUM EASE OF USE

The control panel is movable and can be freely positioned for ergonomic operation during setup and operation of the machine.

- | Programming in close proximity to the workpiece
- | During series operation, the control panel can be moved to the side

CUTTING ROBOT QCUT 600 BOT

ACCESSORIES



RECIRCULATION



BELT FILTER SYSTEM



CENTRIFUGAL

COOLING UNIT

Compact, integrable cooling system for standard applications.

- | Can be integrated into the housing and extended
- | Multi-chamber filtration
- | Inlet sieve with filter bag (see consumables)

Large cooling and filter system for continuous operation, e.g. in serial applications.

- | Tank size: 285 l
- | Filtering capacity: 100 l/min (referring emulsion)
- | Pump capacity: 100 l/min

SEPARATOR

Work safety: Working environment with improved air quality.

- | Removes coolant mist
- | Purifies the air and increases visibility
- | Exhaust power 452 or 500 m³/h depending on voltage

PERFECT CUTTING - CUT-OFF WHEELS FROM QATM

Cutting is more reliable, safe and efficient when processed with the right ingredients: knowledge, care and the right choice of consumables and instruments. The Qprep range includes specially developed cut-off wheels for a wide variety of materials and requirements.

- | Low thermal influence on the specimen during the cutting process
- | Wet abrasive cutting achieves very fine surface finishes after cutting
- | Optimal cutting shortens the further preparation process



FAST, POWERFUL, FLEXIBLE - QTOOL CLAMPING DEVICES

Our innovative clamping devices are used to clamp workpieces securely and precisely to ensure exact cutting and grinding processes. There is a wide range of different clamping devices that have been developed for specific applications and workpiece sizes.

- | Suitable for regular and irregularly shaped samples
- | Fast, repeat-accurate clamping of regularly shaped samples
- | Large range of different clamping tools and systems available

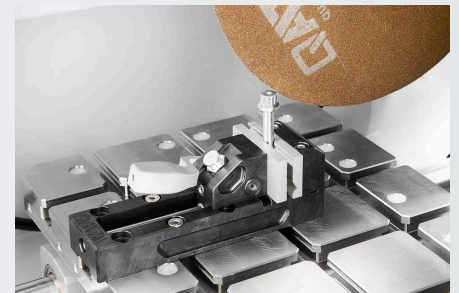

CUTTING ROBOT QCUT 600 BOT

TECHNICAL DATA







Machine configurable with 4 (X/Y/Z/B) or 5 axes (X/Y/Z/B/C)

www.qatm.com/qcut-600-bot

ORDER DATA

BASIC EQUIPMENT



MACHINE (ALL ITEMS REQUIRED)

M1831001		Qcut 600 BOT (4-axis) base machine 400V 50Hz (3Ph/N/PE)
M1831003		Qcut 600 BOT (5-axis) base machine 400V 50Hz (3Ph/N/PE)
M1831002		Qcut 600 BOT (4-axis) base machine 480V 60Hz (3Ph/PE)
M1831004		Qcut 600 BOT (5-axis) base machine 480V 60Hz (3Ph/PE)

WHEEL GUARD (1 ITEM REQUIRED)

A1831001	Wheel guard 500mm
A1831010	Wheel guard 600mm

RECIRCULATION SYSTEM (1 ITEM REQUIRED)

A1831005		Recirculation cooling system 400V 50Hz (3Ph/PE)
A1831006		Recirculation cooling system 480V 60Hz (3Ph/PE)
A6501000		Belt filter 285 400V 50Hz (3Ph/PE)
A6501002		Belt filter 285 480V 60Hz (3Ph/PE)
Z6501007		Connection set belt filter 285

OPTIONS (TO BE ORDERED WITH MACHINE)

A1831004		Laser alignment aid
A1831007		Centrifugal separator 400V 50Hz (3Ph/PE)
A1831009		Centrifugal separator 480V 60Hz (3Ph/PE)

PRECISION CLAMPING DEVICES, CLAMPING_DEVICES, PRECISION_CLAMPING_DEVICES

Z1870063	Reduction ring Ø 30 mm, Clamping_devices, Precision_clamping_devices
Z1870069	Manual chuck Ø 44 mm, Clamping_devices, Precision_clamping_devices

QUICK CLAMPING TOOLS, CLAMPING_DEVICES

QTOOL 80, CLAMPING_DEVICES, QTOOL_SERIES

Z2231203	Qtool 80 - 100mm, Clamping_devices, Qtool_series
Z2231204	Qtool 80 - 150mm, Clamping_devices, Qtool_series
02231243	Clamping jaw 40 mm, Clamping_devices, Qtool_series
Z2231215	Clamping jaws 70 mm, Clamping_devices, Qtool_series
02231245	Clamping jaw 40 mm bevelled, Clamping_devices, Qtool_series
02231246	Clamping jaw 40 mm cross prism, Clamping_devices, Qtool_series
Z2231216	Clamping jaws 70 mm slotted, Clamping_devices, Qtool_series
Z2231217	Clamping jaws 70 mm slotted prism, Clamping_devices, Qtool_series

QTOOL 80 VARIO, CLAMPING_DEVICES, QTOOL_SERIES

Z2231200	Qtool 80 Vario - 100 mm, Clamping_devices, Qtool_series
Z2231201	Qtool 80 Vario - 150 mm, Clamping_devices, Qtool_series
Z2231202	Qtool 80 Vario - 250 mm, Clamping_devices, Qtool_series
Z2231210	Workpiece stop, Clamping_devices, Qtool_series
02231200	Clamping jaw, 40 mm - for Qtool 80 Vario, Clamping_devices, Qtool_series
Z2231211	Clamping jaws, 70 mm, Clamping_devices, Qtool_series
02231213	Prism jaw, 40 mm, Clamping_devices, Qtool_series
02231229	Bevelled jaw, 40 mm, Clamping_devices, Qtool_series
02231230	Cross prism jaw, 40 mm, Clamping_devices, Qtool_series
Z2231212	Round bar jaws, 70 mm slotted, Clamping_devices, Qtool_series
Z2231213	Prism jaws, 70 mm slotted, Clamping_devices, Qtool_series
Z2231214	Clamping jaws, 70 mm slotted, Clamping_devices, Qtool_series

POWER CLAMPING SYSTEMS, CLAMPING_DEVICES, POWER_CLAMPING_SYSTEMS

POWER CLAMPING SYSTEM 100-540, CLAMPING_DEVICES, POWER_CLAMPING_SYSTEMS

Z2234016	Power clamping system 100-540, Clamping_devices, Power_clamping_systems
Z2234018	Prism clamping jaw, Clamping_devices, Power_clamping_systems
Z2234017	Clamping jaw flat, Clamping_devices, Power_clamping_systems
Z2234019	Angular drive, Clamping_devices, Power_clamping_systems

POWER CLAMPING SYSTEM LC 90, CLAMPING_DEVICES, POWER_CLAMPING_SYSTEMS

Z2234001	Power clamping system LC 90, Clamping_devices, Power_clamping_systems
Z2234003	Carrier jaws LC 90, Clamping_devices, Power_clamping_systems
Z2234004	V-groove jaw 100, Clamping_devices, Power_clamping_systems
Z2234005	Clamping jaw flat, Clamping_devices, Power_clamping_systems
Z2234009	Quick-change adapter, Clamping_devices, Power_clamping_systems
Z2234008	Step jaw 100, Clamping_devices, Power_clamping_systems
Z2234002	Clamping system X-Clamp 100, Clamping_devices, Power_clamping_systems
Z2234006	Socket 90°, Clamping_devices, Power_clamping_systems

EASY-CLAMPING PLATES, CLAMPING_DEVICES, EASY_CLAMPING_PLATES

CLAMPING ACCESSORIES FOR ROTATING, SWIVELING AND SPECIAL APPLICATIONS, CLAMPING_DEVICES, CLAMPING_ACCESSORIES_SPECIALS

Z1304636	Expansion clamping device, Clamping_devices, Clamping_accessories_specials
Z1340000	 Cross vice 80 - 100, Clamping_devices, Clamping_accessories_specials
Z1340001	Cross vice 80 - 150, Clamping_devices, Clamping_accessories_specials



ANGLE AND ROTATING VICES, CLAMPING_DEVICES, CLAMPING_ACCESSORIES_SPECIALS

Z1304001	Angle vice 60, Clamping_devices, Clamping_accessories_specials
01304008	Prism jaw angle vice 60, Clamping_devices, Clamping_accessories_specials
Z1302000	Angle vice 80, Clamping_devices, Clamping_accessories_specials
01302016	Prism jaw angle vice 80, Clamping_devices, Clamping_accessories_specials

ROTATIG DEVICES, CLAMPING_DEVICES, ROTATION_DEVICES

Z1870059	Rotation device type RD1, Clamping_devices, Rotation_devices
Z1891001	Rotation device type RD2.1, Clamping_devices, Rotation_devices

UNIVERSAL VICES AND ACCESSORIES, CLAMPING_DEVICES, UNIVERSAL_VICES_AND_ACCESSORIES

Z1350025	Clamping rail, Clamping_devices, Universal_vices_and_accessories
01350022	Prism 120°, Clamping_devices, Universal_vices_and_accessories
01350023	Prism slim, Clamping_devices, Universal_vices_and_accessories
01350024	Prism 90°, Clamping_devices, Universal_vices_and_accessories
01350025	Prism 90° high, Clamping_devices, Universal_vices_and_accessories
Z1350002	 Universal vice Mono 61, Clamping_devices, Universal_vices_and_accessories
Z1350004	 Suitcase set universal vice Mono 61, Clamping_devices, Universal_vices_and_accessories
Z1350011	 Universal vice Mono 132, Clamping_devices, Universal_vices_and_accessories
Z1350005	Universal vice Duo, Clamping_devices, Universal_vices_and_accessories
Z1350006	Chain vice set, Clamping_devices, Universal_vices_and_accessories
92005796	Longitudinal v-shoe, Clamping_devices, Universal_vices_and_accessories
92005797	Traverse v-shoe, Clamping_devices, Universal_vices_and_accessories
92005799	Longitudinal bridge, Clamping_devices, Universal_vices_and_accessories
92005800	Traverse bridge, Clamping_devices, Universal_vices_and_accessories
92005798	Standard clamping shoe, Clamping_devices, Universal_vices_and_accessories
Z1350007	Height adapter 60mm Piccolo, Clamping_devices, Universal_vices_and_accessories
Z1350003	Height adapter 74mm Mono, Clamping_devices, Universal_vices_and_accessories

95003172	Clamping arm extension Piccolo 54 and Mono 61, Clamping_devices, Universal_vices_and_accessories
Z1304591	Fixing screw M6 x 25, Clamping_devices, Universal_vices_and_accessories
95003169	Fixing screw Piccolo M8 x 25, Clamping_devices, Universal_vices_and_accessories
95003170	Fixing screw Piccolo M10 x 25, Clamping_devices, Universal_vices_and_accessories
95003168	Fixing screw Mono M10 x 32, Clamping_devices, Universal_vices_and_accessories
91001157	T-slot nut - stainless M6 x 8, Clamping_devices, Universal_vices_and_accessories
91001161	T-slot nut - stainless M8 x 10, Clamping_devices, Universal_vices_and_accessories
91001159	T-slot nut - stainless M8 x 12, Clamping_devices, Universal_vices_and_accessories
91001158	T-slot nut - stainless M10 x 12, Clamping_devices, Universal_vices_and_accessories