



CUT-OFF MACHINE

## QCUT 250 A

**The Qcut 250 A is a compact and flexible semi-automatic abrasive cut-off machine with a 254 mm / 10" cut-off wheel for workpieces or samples up to Ø 95 mm. This machine combines the benefits and speed of a manual cut-off machine with the advantages of an automatic abrasive cutter.**

The semi-automatic Qcut 250 A, equipped with a hand lever and automatic lever brake, can be operated with one hand and makes vertical cuts or the positioning of the cut-off wheel easier than before. The cutting table with T-slots is made of stainless steel and can be used either with a dynamic automatic drive (allows pulsed cut) or in manual mode, operated by a hand wheel (traverse cut). Together with the well-proven QATM technology of pulsed cutting, the Qcut 250 A provides excellent cutting results even with the most difficult materials. And having an automatic X-axis allows the Care-Cut (oscillation cut) during a chop cut for large pieces.

For more complex cutting tasks, the Qcut 250 A can be equipped with an optional automatic cross table to perform serial cuts. Axes are monitored by travel measuring during set up and operation.



[Click to view video](#)

## PRODUCT ADVANTAGES

- | Manual Y-axis with electromechanical lever brake
- | Care-Cut: facilitates gentle cutting

- | 7" Touch-Screen user interface with intuitive QATM user software
- | Automatic travel X-axis - manual travel via hand wheel
- | Cutting-force dependent feed control (X-axis)
- | Superior LED illumination of cutting chamber
- | Parallel setting of wheel guard during cutting sequences increases cutting capacity
- | Opening on both sides for long parts

## FEATURES

### FINE DYNAMIC CUT-OFF

With the manual cutting movement, the cutting force is regulated through a set of gears. The cut is thereby jerk-free and more precise. The easy-to-use lever brake fixes the cutting disc in any position.

### HORIZONTAL MOVEMENT

The manual horizontal or automatic movement allows cutting long parts longitudinally and easy positioning of the sample below the cut-off wheel. In pulsed cutting mode the sample material is cut particularly gently.

### INTUITIVE CONTROL SOFTWARE

The new control software with integrated, extensive maintenance menu makes the operation simple and comfortable.

### AUTOMATIC CROSS FEED

The automatic Z-axis can be adjusted with 0.1 mm precision for parallel cuts.

CUT-OFF MACHINE QCUT 250 A

## SUPERIORITY IN DETAIL

**1. Large machine table**

**5. Side opening**

- | Axes can be positioned backlash-free
- | Easy grooves for simple mounting of QATM clamping devices
- | T-slots 12 mm for individual clamping devices
- | Max. W x H: 380 mm x 270 mm (without Z-axis), otherwise 300 mm x 270

## 2. Ergonomic control panel

- | 10,1" color touch display
- | Joystick for manual operation

## 3. Laser alignment

- | For exact component part positioning before cutting

## 4. Cut-off wheel lock

- | Simplified cutting disc replacement via locking mechanism and easy nut system

- | For exact component part positioning before cutting

## 6. Robust housing

- | Sturdy powder-coated aluminum construction

## 7. Parallel-guided cutting disc cover

- | Increased cutting capacity in cross-cutting

## 8 Large hand lever

- | Hand lever for precise cross-cuts with automatic locking brake



## PERFECT CUTTING - CUT-OFF WHEELS FROM QATM

Cutting is more reliable, safe and efficient when processed with the right ingredients: knowledge, care and the right choice of consumables and instruments.



## FAST, POWERFUL, FLEXIBLE - QTOOL CLAMPING DEVICES

Our innovative clamping devices are used to clamp workpieces securely and precisely to ensure exact cutting and grinding processes. There is a wide range of different clamping devices that have been developed for specific applications and workpiece sizes.

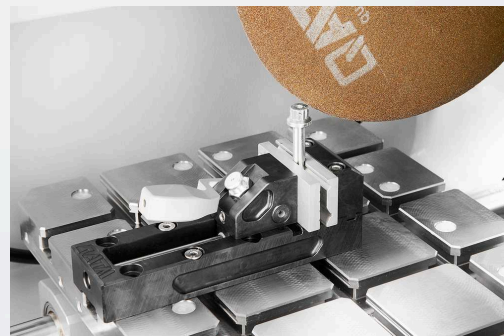

CUT-OFF MACHINE QCUT 250 A

**TECHNICAL DATA**

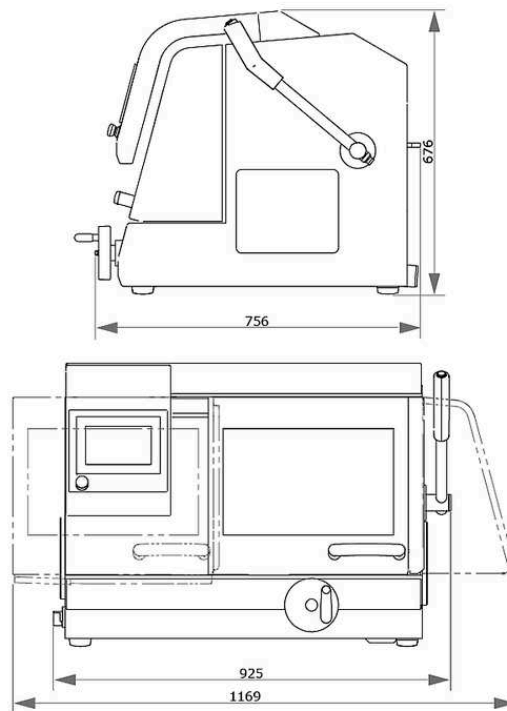

<b>Cutting wheel</b>	up to 254 mm / 10"
<b>Max. cutting capacity</b>	∅ 95 mm
<b>X-axis automatic &amp; manual</b>	225 mm
<b>Y-axis manual</b>	170 mm
<b>Z-axis automatic (option)</b>	120 mm
<b>Precision Z-axis</b>	0.1 mm
<b>Table without Z-axis WxD</b>	380 x 270 mm
<b>Table with Z-axis WxD</b>	300 x 270 mm
<b>T-slot</b>	12 mm
<b>Connection power</b>	5.5 kVA
<b>Drive power (main drive)</b>	3 kW, S1; 4 kW, S3/60%
<b>Speed</b>	3015 rpm at 50Hz and 3100 rpm at 60Hz
<b>W x H x D</b>	925 x 676 x 756 mm
<b>Weight (depends on equipment)</b>	~ 130 kg

[www.qatm.com/qcut-250-a](http://www.qatm.com/qcut-250-a)

## ORDER DATA

### BASIC EQUIPMENT

#### MACHINE (ALL ITEMS REQUIRED)

M1822000  Qcut 250 A (Brillant 240) Base machine

#### POWER SUPPLY (1 ITEM REQUIRED)

A1822001 Qcut 250 A power connection 400V/50Hz (3Ph/PE)

A1822002 Qcut 250 A power connection 480V/60Hz (3Ph/PE)

A1822003 Qcut 250 A power connection 220V/60Hz (3Ph/PE)

#### TABLE DRIVE BRILLANT (1 ITEM REQUIRED)

A1822004 Qcut 250 A X-Axis aut.&manual / without Z-Axis

A1822005 Qcut 250 A X-Axis aut.&manual / Z-Axis aut.

#### RECIRCULATION SYSTEM (1 ITEM REQUIRED)

A5800484  Recirculation Cooling System 45L 400V/50Hz (3Ph/PE) mobile, with insertion mechanism

A5800485  Recirculation Cooling System 45L 480V/60Hz (3Ph/PE) mobile, with insertion mechanism



A5800486  Recirculation Cooling System 45L 220V/60Hz (3Ph/PE) mobile, with insertion mechanism

A5800487  Recirculation Cooling System 45L 400V/50Hz (3Ph/PE) mobile, without folding wheels



A5800488  Recirculation Cooling System 45L 480V/60Hz (3Ph/PE) mobile, without folding wheels

A5800489  Recirculation Cooling System 45L 220V/60Hz (3Ph/PE) mobile, without folding wheels

A6501009  Belt filter 130 - 400V/50Hz (3Ph/PE)

A6501011		Belt filter 130 - 480V/60Hz (3Ph/PE)
A6501010		Belt filter 130 - 220V/60Hz (3Ph/PE)
Z6501004		Connection set belt filter 130

## OPTIONS (TO BE ORDERED WITH MACHINE)

A1822006		Qcut 250 A laser alignment aid
A1822007		Qcut 250 A centrifugal separator 400V 50Hz/480V 60Hz
A1822008		Qcut 250 A centrifugal separator 220V 60Hz

## PRECISION CLAMPING DEVICES, CLAMPING\_DEVICES, PRECISION\_CLAMPING\_DEVICES

Z1870035		Sample holder L standard Ø 40 mm open, Clamping_devices, Precision_clamping_devices
Z1870037		Sample holder L standard Ø 40 mm closed, Clamping_devices, Precision_clamping_devices
Z1870039		Sample holder L Flex Ø 40 mm, Clamping_devices, Precision_clamping_devices
Z1870043		Sample holder L parallel clamping vice open, Clamping_devices, Precision_clamping_devices
Z1870041		Sample holder L parallel clamping vice closed, Clamping_devices, Precision_clamping_devices
Z1870045		Drop shape sample holder L Ø 40 mm, Clamping_devices, Precision_clamping_devices
Z1870047		Universal clamping vice L, Clamping_devices, Precision_clamping_devices
Z1870049		Matrix clamping vice L, Clamping_devices, Precision_clamping_devices
Z1870054		Mini vice L, Clamping_devices, Precision_clamping_devices
Z1870056		Double parallel vice L, Clamping_devices, Precision_clamping_devices
Z1870058		Adaptor with ball joint L, Clamping_devices, Precision_clamping_devices
Z1870064		Reduction ring Ø 25 mm, Clamping_devices, Precision_clamping_devices
Z1870063		Reduction ring Ø 30 mm, Clamping_devices, Precision_clamping_devices

Z1870071	Reduction ring Ø 40 mm, Clamping_devices, Precision_clamping_devices
Z1870067	Reduction ring 1", Clamping_devices, Precision_clamping_devices
Z1870066	Reduction ring 1 1/4", Clamping_devices, Precision_clamping_devices
Z1870065	Reduction ring 1 1/2", Clamping_devices, Precision_clamping_devices
Z1870068	Manual chuck Ø 32 mm, Clamping_devices, Precision_clamping_devices
Z1870069	Manual chuck Ø 44 mm, Clamping_devices, Precision_clamping_devices
Z1870070	Manual chuck Ø 56 mm, Clamping_devices, Precision_clamping_devices

#### VACUUM CLAMPING VICES, CLAMPING\_DEVICES, PRECISION\_CLAMPING\_DEVICES

Z1870028	Vacuum sample holder, Clamping_devices, Precision_clamping_devices
01870288	Vacuum holder (sacrificial plate), Clamping_devices, Precision_clamping_devices
Z1304600	Vacuum pump 230V/50Hz for vacuum sample holder, Clamping_devices, Precision_clamping_devices
Z1304634	Vacuum pump 110V/60Hz for vacuum sample holder, Clamping_devices, Precision_clamping_devices

## QUICK CLAMPING TOOLS, CLAMPING\_DEVICES

#### QTOOL 60, CLAMPING\_DEVICES, QTOOL\_SERIES

Z2235200	Qtool 60, Clamping_devices, Qtool_series
02235202	Clamping jaw 32 mm - for Qtool 60, Clamping_devices, Qtool_series
Z2235201	Clamping jaws 60 mm - for Qtool 60, Clamping_devices, Qtool_series
02235212	Clamping jaw 32 mm bevelled - for Qtool 60, Clamping_devices, Qtool_series
02235213	Clamping jaw 32 mm cross prism - for Qtool 60, Clamping_devices, Qtool_series
Z2235202	Clamping jaws 60 mm slotted - for Qtool 60, Clamping_devices, Qtool_series
Z2235203	Clamping jaws 60 mm slotted prism - for Qtool 60, Clamping_devices, Qtool_series

#### QTOOL 80, CLAMPING\_DEVICES, QTOOL\_SERIES

Z2231203	Qtool 80 - 100mm, Clamping_devices, Qtool_series
02231243	Clamping jaw 40 mm, Clamping_devices, Qtool_series
Z2231215	Clamping jaws 70 mm, Clamping_devices, Qtool_series
02231245	Clamping jaw 40 mm bevelled, Clamping_devices, Qtool_series

02231246	Clamping jaw 40 mm cross prism, Clamping_devices, Qtool_series
Z2231216	Clamping jaws 70 mm slotted, Clamping_devices, Qtool_series
Z2231217	Clamping jaws 70 mm slotted prism, Clamping_devices, Qtool_series

#### QTOOL 80 VARIO, CLAMPING\_DEVICES, QTOOL\_SERIES

Z2231200	Qtool 80 Vario - 100 mm, Clamping_devices, Qtool_series
Z2231210	Workpiece stop, Clamping_devices, Qtool_series
02231200	Clamping jaw, 40 mm - for Qtool 80 Vario, Clamping_devices, Qtool_series
Z2231211	Clamping jaws, 70 mm, Clamping_devices, Qtool_series
02231213	Prism jaw, 40 mm, Clamping_devices, Qtool_series
02231229	Bevelled jaw, 40 mm, Clamping_devices, Qtool_series
02231230	Cross prism jaw, 40 mm, Clamping_devices, Qtool_series
Z2231212	Round bar jaws, 70 mm slotted, Clamping_devices, Qtool_series
Z2231213	Prism jaws, 70 mm slotted, Clamping_devices, Qtool_series
Z2231214	Clamping jaws, 70 mm slotted, Clamping_devices, Qtool_series

## EASY-CLAMPING PLATES, CLAMPING\_DEVICES, EASY\_CLAMPING\_PLATES

Z2236030	Easy-clamping plate S, Clamping_devices, Easy_clamping_plates
Z2236031	Easy-clamping plate S with rotating unit, Clamping_devices, Easy_clamping_plates
Z2236035	Easy-clamping plate M, Clamping_devices, Easy_clamping_plates

## ACCESSORIES FOR EASY-CLAMPING PLATES

Z2236032	Easy adaption horizontal, Clamping_devices, Easy_clamping_plates
Z2236033	Easy adaption vertical, Clamping_devices, Easy_clamping_plates
Z2236034	Easy adaption Qtool 40 - 60, Clamping_devices, Easy_clamping_plates
Z2236038	Multitower rotating plate, Clamping_devices, Easy_clamping_plates
Z2236039	Multitower, Clamping_devices, Easy_clamping_plates
Z2236040	Swivel unit Qtool 40 - 60, Clamping_devices, Easy_clamping_plates
Z2236036	Easy-multifunctional plate, Clamping_devices, Easy_clamping_plates

## CLAMPING ACCESSORIES FOR ROTATING, SWIVELING AND SPECIAL APPLICATIONS, CLAMPING\_DEVICES, CLAMPING\_ACCESSORIES\_SPECIALS

Z2236041	Swivel unit Qtool 60 - 80, Clamping_devices, Clamping_accessories_specials
Z1304643	Screw clamber with Easy-clamping plate M, Clamping_devices, Clamping_accessories_specials
Z1304636	Expansion clamping device, Clamping_devices, Clamping_accessories_specials
Z2236009	Vertical clamp single, Clamping_devices, Clamping_accessories_specials
Z2236010	Vertical clamp double, Clamping_devices, Clamping_accessories_specials
Z2234010	Clamping system X-Clamp 3858, Clamping_devices, Clamping_accessories_specials

### CROSS VICES, CLAMPING\_DEVICES, CLAMPING\_ACCESSORIES\_SPECIALS

Z1340010	 Cross vice 50 - 100, Clamping_devices, Clamping_accessories_specials
----------	---

### ANGLE AND ROTATING VICES, CLAMPING\_DEVICES, CLAMPING\_ACCESSORIES\_SPECIALS





Z1304001	Angle vice 60, Clamping_devices, Clamping_accessories_specials
01304008	Prism jaw angle vice 60, Clamping_devices, Clamping_accessories_specials

## ROTATING DEVICES, CLAMPING\_DEVICES, ROTATION\_DEVICES

Z1870059	Rotation device type RD1, Clamping_devices, Rotation_devices
Z1891001	Rotation device type RD2.1, Clamping_devices, Rotation_devices

## UNIVERSAL VICES AND ACCESSORIES, CLAMPING\_DEVICES, UNIVERSAL\_VICES\_AND\_ACCESSORIES

01350022	Prism 120°, Clamping_devices, Universal_vices_and_accessories
01350023	Prism slim, Clamping_devices, Universal_vices_and_accessories
01350024	Prism 90°, Clamping_devices, Universal_vices_and_accessories
01350025	Prism 90° high, Clamping_devices, Universal_vices_and_accessories
Z1350008	 Universal vice Piccolo 54, Clamping_devices, Universal_vices_and_accessories

Z1350010		Suitcase set universal vice Piccolo 54, Clamping_devices, Universal_vices_and_accessories
Z1350012		Universal vice Piccolo 100, Clamping_devices, Universal_vices_and_accessories
Z1350002		Universal vice Mono 61, Clamping_devices, Universal_vices_and_accessories
Z1350004		Suitcase set universal vice Mono 61, Clamping_devices, Universal_vices_and_accessories
Z1350011		Universal vice Mono 132, Clamping_devices, Universal_vices_and_accessories
Z1350005		Universal vice Duo, Clamping_devices, Universal_vices_and_accessories
Z1350006		Chain vice set, Clamping_devices, Universal_vices_and_accessories
92005796		Longitudinal v-shoe, Clamping_devices, Universal_vices_and_accessories
92005797		Traverse v-shoe, Clamping_devices, Universal_vices_and_accessories
92005799		Longitudinal bridge, Clamping_devices, Universal_vices_and_accessories
92005800		Traverse bridge, Clamping_devices, Universal_vices_and_accessories
92005798		Standard clamping shoe, Clamping_devices, Universal_vices_and_accessories
Z1350007		Height adapter 60mm Piccolo, Clamping_devices, Universal_vices_and_accessories
Z1350003		Height adapter 74mm Mono, Clamping_devices, Universal_vices_and_accessories
95003172		Clamping arm extension Piccolo 54 and Mono 61, Clamping_devices, Universal_vices_and_accessories
Z1304591		Fixing screw M6 x 25, Clamping_devices, Universal_vices_and_accessories
95003169		Fixing screw Piccolo M8 x 25, Clamping_devices, Universal_vices_and_accessories
95003170		Fixing screw Piccolo M10 x 25, Clamping_devices, Universal_vices_and_accessories
95003168		Fixing screw Mono M10 x 32, Clamping_devices, Universal_vices_and_accessories
91001157		T-slot nut - stainless M6 x 8, Clamping_devices, Universal_vices_and_accessories
91001161		T-slot nut - stainless M8 x 10, Clamping_devices, Universal_vices_and_accessories
91001159		T-slot nut - stainless M8 x 12, Clamping_devices, Universal_vices_and_accessories
91001158		T-slot nut - stainless M10 x 12, Clamping_devices, Universal_vices_and_accessories