



切割机

QCUT 250 M

Qcut 250 M是一款界面极其友好的手动湿式砂轮切割机。打开机器将前窗推入机器内部，整个切割室更容易接近。圆弧形视窗扩大了切割过程中的视场。

切割轮冷却直接集成在切割片防护罩中。大尺寸不锈钢工作台配有可更换的耐磨台面。横向凹槽有利于调整夹具至最佳位置（如夹具80）。

优点

- | 手动纵向移动
- | 宽敞的切割空间
- | 仪器两侧的开口可以切割较长的样品
- | 大尺寸台面配有可更换的耐磨板
- | 与机器同宽同高的透明机罩可获得最佳的操控性
- | 简单易用
- | 多种样品夹具和夹持系统可供选择
- | 符合最新安全标准的门互锁系统
- | 坚固的铝壳设计，表面为粉末涂层

性能指标

精细动态切割

Y轴的手动切割运动通过操纵杆精确无误地执行，无抖动。操纵杆的长度和角度均可调节。此外，还可通过限位器轻松调整切割深度。

照明

通过圆形大窗，切割室一览无余。为了直接照明，Qcut 250 M 可以配备灵活的LED灯。

安全

集成的静止监控功能只允许在切割轮不旋转时打开切割室门。

完美的切割 - 由QPREP耗材保证

当使用正确的元素: 知识、保养和正确选择耗材和切割机进行加工时, 切割更可靠、更安全、更高效。



快速、强大、灵活-QTOOLS 夹具

我们创新的夹具用于安全、精确地夹紧工件, 以确保精确的切割和磨削过程。针对特定的应用和工件尺寸, 我们已经开发了各种不同的夹具。

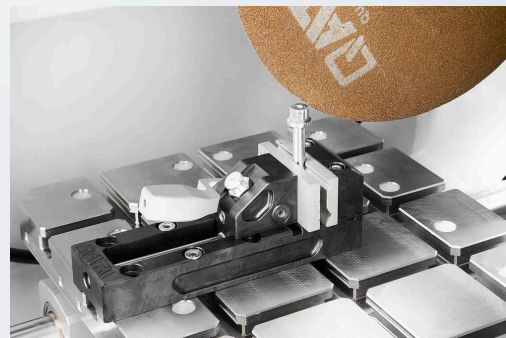

切割机 QCUT 250 M

技术参数

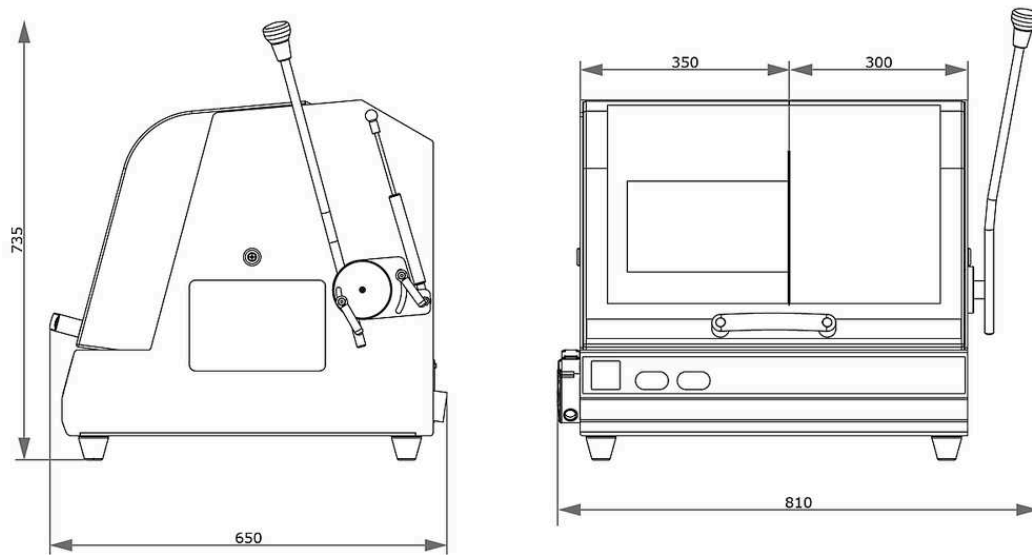

切割轮	up to \varnothing 250 mm/10"
最大切割能力	\varnothing 55 mm / \varnothing 90 mm 连续切割 (长度可达25mm)
切割轮法兰尺寸	\varnothing 32 mm
Y轴 (垂直移动)	145 mm
载物台 宽x深	350 x 288 mm 不锈钢
T型槽	12 mm
连接电源	4.5 kVA
工作功率 (主载荷)	3 kW S6 40%
宽 x 高 x 深	810 x 735 x 650 mm
重量	~ 75 kg

www.qatm.cn/qcut-250-m

ORDER DATA

BASIC EQUIPMENT







MACHINE (ALL ITEMS REQUIRED)

M1880000		Qcut 250 M (Brillant 200) Base machine
----------	---	--



POWER SUPPLY (1 ITEM REQUIRED)

A1880000	Qcut 250 M power supply 400V/50Hz (3Ph/N/PE)
A1880001	Qcut 250 M power supply 480V/60Hz (3/PE)
A1880002	Qcut 250 M power supply 220V/60Hz (3/PE)

RECIRCULATION SYSTEM (1 ITEM REQUIRED)

A5800484		Recirculation Cooling System 45L 400V/50Hz (3Ph/PE) mobile, with insertion mechanism
A5800485		Recirculation Cooling System 45L 480V/60Hz (3Ph/PE) mobile, with insertion mechanism
A5800486		Recirculation Cooling System 45L 220V/60Hz (3Ph/PE) mobile, with insertion mechanism
A5800487		Recirculation Cooling System 45L 400V/50Hz (3Ph/PE) mobile, without folding wheels
A5800488		Recirculation Cooling System 45L 480V/60Hz (3Ph/PE) mobile, without folding wheels
A5800489		Recirculation Cooling System 45L 220V/60Hz (3Ph/PE) mobile, without folding wheels

OPTIONS (TO BE ORDERED WITH MACHINE)

Z1820009		Centrifugal separator (machine mounted) 400V/50Hz/3 Ph
Z1820012		Centrifugal separator (machine mounted) 480V/60Hz/3 Ph

Z1820011



Centrifugal separator (machine mounted) 220V/60Hz/3 Ph

PRECISION CLAMPING DEVICES, CLAMPING_DEVICES, PRECISION_CLAMPING_DEVICES

Z1870035	Sample holder L standard Ø 40 mm open, Clamping_devices, Precision_clamping_devices
Z1870037	Sample holder L standard Ø 40 mm closed, Clamping_devices, Precision_clamping_devices
Z1870039	Sample holder L Flex Ø 40 mm, Clamping_devices, Precision_clamping_devices
Z1870043	Sample holder L parallel clamping vice open, Clamping_devices, Precision_clamping_devices
Z1870041	Sample holder L parallel clamping vice closed, Clamping_devices, Precision_clamping_devices
Z1870045	Drop shape sample holder L Ø 40 mm, Clamping_devices, Precision_clamping_devices
Z1870047	Universal clamping vice L, Clamping_devices, Precision_clamping_devices
Z1870049	Matrix clamping vice L, Clamping_devices, Precision_clamping_devices
Z1870054	Mini vice L, Clamping_devices, Precision_clamping_devices
Z1870056	Double parallel vice L, Clamping_devices, Precision_clamping_devices
Z1870058	Adaptor with ball joint L, Clamping_devices, Precision_clamping_devices
Z1870063	Reduction ring Ø 30 mm, Clamping_devices, Precision_clamping_devices
Z1870071	Reduction ring Ø 40 mm, Clamping_devices, Precision_clamping_devices
Z1870067	Reduction ring 1", Clamping_devices, Precision_clamping_devices
Z1870066	Reduction ring 1 1/4", Clamping_devices, Precision_clamping_devices
Z1870065	Reduction ring 1 1/2", Clamping_devices, Precision_clamping_devices
Z1870069	Manual chuck Ø 44 mm, Clamping_devices, Precision_clamping_devices
Z1870070	Manual chuck Ø 56 mm, Clamping_devices, Precision_clamping_devices

VACUUM CLAMPING VICES, CLAMPING_DEVICES, PRECISION_CLAMPING_DEVICES

Z1870028	Vacuum sample holder, Clamping_devices, Precision_clamping_devices
01870288	Vacuum holder (sacrificial plate), Clamping_devices, Precision_clamping_devices

Z1304600	Vacuum pump 230V/50Hz for vacuum sample holder, Clamping_devices, Precision_clamping_devices
Z1304634	Vacuum pump 110V/60Hz for vacuum sample holder, Clamping_devices, Precision_clamping_devices

QUICK CLAMPING TOOLS, CLAMPING_DEVICES

QTOOL 60, CLAMPING_DEVICES, QTOOL_SERIES

Z2235200	Qtool 60, Clamping_devices, Qtool_series
02235202	Clamping jaw 32 mm - for Qtool 60, Clamping_devices, Qtool_series
Z2235201	Clamping jaws 60 mm - for Qtool 60, Clamping_devices, Qtool_series
02235212	Clamping jaw 32 mm bevelled - for Qtool 60, Clamping_devices, Qtool_series
02235213	Clamping jaw 32 mm cross prism - for Qtool 60, Clamping_devices, Qtool_series
Z2235202	Clamping jaws 60 mm slotted - for Qtool 60, Clamping_devices, Qtool_series
Z2235203	Clamping jaws 60 mm slotted prism - for Qtool 60, Clamping_devices, Qtool_series

QTOOL 80, CLAMPING_DEVICES, QTOOL_SERIES

Z2231203	Qtool 80 - 100mm, Clamping_devices, Qtool_series
02231243	Clamping jaw 40 mm, Clamping_devices, Qtool_series
Z2231215	Clamping jaws 70 mm, Clamping_devices, Qtool_series
02231245	Clamping jaw 40 mm bevelled, Clamping_devices, Qtool_series
02231246	Clamping jaw 40 mm cross prism, Clamping_devices, Qtool_series
Z2231216	Clamping jaws 70 mm slotted, Clamping_devices, Qtool_series
Z2231217	Clamping jaws 70 mm slotted prism, Clamping_devices, Qtool_series

QTOOL 80 VARIO, CLAMPING_DEVICES, QTOOL_SERIES

Z2231200	Qtool 80 Vario - 100 mm, Clamping_devices, Qtool_series
Z2231210	Workpiece stop, Clamping_devices, Qtool_series
02231200	Clamping jaw, 40 mm - for Qtool 80 Vario, Clamping_devices, Qtool_series
Z2231211	Clamping jaws, 70 mm, Clamping_devices, Qtool_series
02231213	Prism jaw, 40 mm, Clamping_devices, Qtool_series
02231229	Bevelled jaw, 40 mm, Clamping_devices, Qtool_series

02231230	Cross prism jaw, 40 mm, Clamping_devices, Qtool_series
Z2231212	Round bar jaws, 70 mm slotted, Clamping_devices, Qtool_series
Z2231213	Prism jaws, 70 mm slotted, Clamping_devices, Qtool_series
Z2231214	Clamping jaws, 70 mm slotted, Clamping_devices, Qtool_series

EASY-CLAMPING PLATES, CLAMPING_DEVICES, EASY_CLAMPING_PLATES

ACCESSORIES FOR EASY-CLAMPING PLATES

Z2236032	Easy adaption horizontal, Clamping_devices, Easy_clamping_plates
Z2236033	Easy adaption vertical, Clamping_devices, Easy_clamping_plates
Z2236034	Easy adaption Qtool 40 - 60, Clamping_devices, Easy_clamping_plates
Z2236038	Multitower rotating plate, Clamping_devices, Easy_clamping_plates
Z2236039	Multitower, Clamping_devices, Easy_clamping_plates
Z2236040	Swivel unit Qtool 40 - 60, Clamping_devices, Easy_clamping_plates
Z2236036	Easy-multifunctional plate, Clamping_devices, Easy_clamping_plates







CLAMPING ACCESSORIES FOR ROTATING, SWIVELING AND SPECIAL APPLICATIONS, CLAMPING_DEVICES, CLAMPING_ACCESSORIES_SPECIALS

Z2236041	Swivel unit Qtool 60 - 80, Clamping_devices, Clamping_accessories_specials
Z1304643	Screw clamber with Easy-clamping plate M, Clamping_devices, Clamping_accessories_specials
Z1304636	Expansion clamping device, Clamping_devices, Clamping_accessories_specials
Z2236009	Vertical clamp single, Clamping_devices, Clamping_accessories_specials
Z2236010	Vertical clamp double, Clamping_devices, Clamping_accessories_specials
Z2234010	Clamping system X-Clamp 3858, Clamping_devices, Clamping_accessories_specials

CROSS VICES, CLAMPING_DEVICES, CLAMPING_ACCESSORIES_SPECIALS

Z1340010	 Cross vice 50 - 100, Clamping_devices, Clamping_accessories_specials
----------	--

UNIVERSAL VICES AND ACCESSORIES, CLAMPING_DEVICES, UNIVERSAL_VICES_AND_ACCESSORIES

01350022		Prism 120°, Clamping_devices, Universal_vices_and_accessories
01350023		Prism slim, Clamping_devices, Universal_vices_and_accessories
01350024		Prism 90°, Clamping_devices, Universal_vices_and_accessories
01350025		Prism 90° high, Clamping_devices, Universal_vices_and_accessories
Z1350008		Universal vice Piccolo 54, Clamping_devices, Universal_vices_and_accessories
Z1350010		Suitcase set universal vice Piccolo 54, Clamping_devices, Universal_vices_and_accessories
Z1350012		Universal vice Piccolo 100, Clamping_devices, Universal_vices_and_accessories
Z1350002		Universal vice Mono 61, Clamping_devices, Universal_vices_and_accessories
Z1350004		Suitcase set universal vice Mono 61, Clamping_devices, Universal_vices_and_accessories
Z1350011		Universal vice Mono 132, Clamping_devices, Universal_vices_and_accessories
Z1350005		Universal vice Duo, Clamping_devices, Universal_vices_and_accessories
Z1350006		Chain vice set, Clamping_devices, Universal_vices_and_accessories
92005796		Longitudinal v-shoe, Clamping_devices, Universal_vices_and_accessories
92005797		Traverse v-shoe, Clamping_devices, Universal_vices_and_accessories
92005799		Longitudinal bridge, Clamping_devices, Universal_vices_and_accessories
92005800		Traverse bridge, Clamping_devices, Universal_vices_and_accessories
92005798		Standard clamping shoe, Clamping_devices, Universal_vices_and_accessories
Z1350007		Height adapter 60mm Piccolo, Clamping_devices, Universal_vices_and_accessories
Z1350003		Height adapter 74mm Mono, Clamping_devices, Universal_vices_and_accessories
95003172		Clamping arm extension Piccolo 54 and Mono 61, Clamping_devices, Universal_vices_and_accessories
Z1304591		Fixing screw M6 x 25, Clamping_devices, Universal_vices_and_accessories
95003169		Fixing screw Piccolo M8 x 25, Clamping_devices, Universal_vices_and_accessories

95003170	Fixing screw Piccolo M10 x 25, Clamping_devices, Universal_vices_and_accessories
95003168	Fixing screw Mono M10 x 32, Clamping_devices, Universal_vices_and_accessories
91001157	T-slot nut - stainless M6 x 8, Clamping_devices, Universal_vices_and_accessories
91001161	T-slot nut - stainless M8 x 10, Clamping_devices, Universal_vices_and_accessories
91001159	T-slot nut - stainless M8 x 12, Clamping_devices, Universal_vices_and_accessories
91001158	T-slot nut - stainless M10 x 12, Clamping_devices, Universal_vices_and_accessories