



切割机

QCUT 350 A

Qcut 350 A 是一台自动湿式砂轮切割机，可切割最大直径为**135毫米**的样品。由于其**低接触切割(Icc)**功能，它可以轻柔地切割各种几何形状、尺寸和材料的不同类型的样品。

该切割机通常用于金相学、材相学、矿物学，以及复合材料（CFC/PMC/MMC）或电子装置（如PCB）的切割。

该机器的大型切割室和不锈钢工作台使操作舒适而灵活。丰富的基于软件的功能，如自动接触检测、多位置进程和垂直切割时的切割轮保护罩平行设置，进一步提高了切割过程的可重复性。



[点击观看视频](#)

优点

- | 横向自动移动
- | 纵向自动移动
- | 电子控制切割力
- | 电子控制移动距离
- | 电子控制的切割力限制装置
- | 储存切割程序
- | 多种样品夹具和夹持系统可供选择
- | 右侧开口可用于放置长的工件

性能指标

电子性能控制

当达到预设的最大功率时，进给速度会降低。这样可以保护机器及其切割部件，防止过载。

精确横向进给

可选配的自动横向进给和序列切割功能适用于精确的平行切割。通过电子控制进行操作。使用研磨杯轮时，电子横向进给也可用作进给轴。

脉冲切割

在切割重型截面和难以切割的材料时，可变脉冲切割系统具有决定性的优势。

多点进程 MPP

利用 "多点进程" (MPP) 功能，您可以在工作台上放置多个试样，并按一个顺序进行切割。通过示教功能，可以简单方便地设置各种切割位置。

自动接触检测

切割过程自动启动后，样品会快速接近。通过接触切割轮，样品将按照预设的切割参数被高效、安全地切割。

新尺寸

加大的切割室和工作台以及平行设置的砂轮护罩提高了所有轴的切割能力和行程。侧门确保了切割室的最佳进出通道，而用于提供长型样品部件的额外开口则提供了更多可能性。

电子控制

自动横切的切割参数可保存在电子控制装置中，之后再加载。手动横切的位置也会显示在显示屏上。所有参数，如进给速度、行程和切割力，均可在自动切割过程中进行更改。

切割机 QCUT 350 A

超凡细节

1. 大尺寸切割试台

- | 轴可以无反弹定位
- | 简洁的凹槽设计，便于 QATM 夹具的安装
- | 用于单独夹具的 12 毫米 T 型槽
- | 最大宽 x 高: 500 mm x 300 mm (无 Z 轴), 除此外最大 400 mm x 300

2. 人体工学控制面板

- | 10,1" 彩色触摸屏
- | 用于手动操作的操纵杆

3. 激光辅助定位

- | 用于切割前工件的精确定位

4. 切割轮锁定

- | 通过锁定机制和简易螺

5. 侧开口

- | 右侧的开口可以用于放置长的工件

6. 坚固的外壳

- | 坚固的粉末涂层铝质结构

7. 平行导向的切割轮罩盖

- | 交叉切割能力的提升



母系统实现简化的切割
轮更换操作

完美的切割 - 由QPREP耗材保证

当使用正确的元素: 知识、保养和正确选择耗材和切割机进行加工时, 切割更可靠、更安全、更高效。

快速、强大、灵活-QTOOLS 夹具

我们创新的夹具用于安全、精确地夹紧工件, 以确保精确的切割和磨削过程。针对特定的应用和工件尺寸, 我们已经开发了各种不同的夹具。

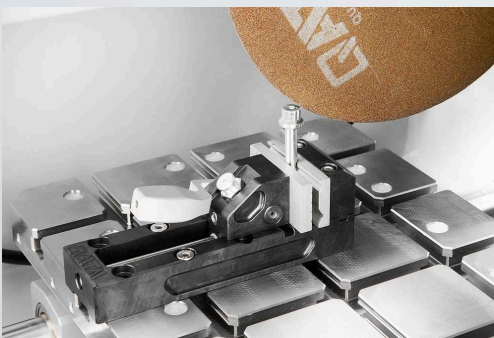

切割机 QCUT 350 A

技术参数

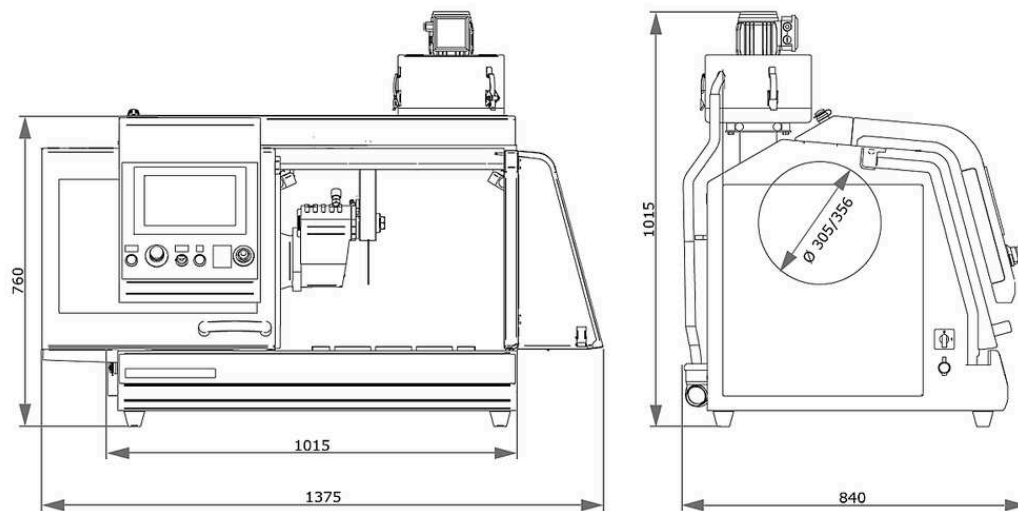

切割轮	up to Ø 356 mm/14"
最大切割能力	Ø 135 mm
切割轮法兰尺寸	Ø 32 mm
自动X轴移动	260 mm
自动Y轴移动	175 mm
Z-轴自动 (可选)	140 mm
Z轴精度	0.1 mm
载物台 (不含Z轴) 宽x深	500 x 300 mm, 不锈钢
载物台 (含Z轴) 宽x深	400 x 300 mm, 不锈钢
T型槽	12 mm
转速	可变转速800-3400转/分
连接电源	9.5 kVA
工作功率 (主载荷)	4 kW S1; 5.5 kW S3
宽 x 高 x 深	1015 x 760 x 810 mm
重量	~200kg(取决于设备)

www.qatm.cn/qcut-350-a

ORDER DATA

BASIC EQUIPMENT

MACHINE (ALL ITEMS REQUIRED)

M1821001		Qcut 350 A (Brillant 250) Base machine
----------	---	--

POWER SUPPLY (1 ITEM REQUIRED)

A1821015	Qcut 350 A power supply 400V (3Ph/PE)
A1821016	Qcut 350 A power supply 480V (3Ph/PE)
A1821017	Qcut 350 A power supply 220V (3Ph/PE)





WHEEL GUARD (1 ITEM REQUIRED)

A1821018	Qcut 350 A wheel guard 305mm 12"
A1821019	Qcut 350 A wheel guard 356mm 14"

CROSS FEED (1 ITEM REQUIRED)

A1821020	Qcut 350 A without Z-axis
A1821021	Qcut 350 A manual Z-axis
A1821022	Qcut 350 A automatic Z-axis

RECIRCULATION SYSTEM (1 ITEM REQUIRED)

A5800507		Recirculation cooling System 45L, mobile, with insertion mechanism
A5800508		Recirculation cooling System 45L, mobile, without folding wheels
A6501009		Belt filter 130 - 400V/50Hz (3Ph/PE)
A6501010		Belt filter 130 - 220V/60Hz (3Ph/PE)
Z6501004		Connection set belt filter 130

OPTIONS (TO BE ORDERED WITH MACHINE)

A1821023		Qcut 350 A laser alignment
A1821024		Qcut 350 A centrifugal separator

PRECISION CLAMPING DEVICES, CLAMPING_DEVICES,
PRECISION_CLAMPING_DEVICES

Z1870035	Sample holder L standard Ø 40 mm open, Clamping_devices, Precision_clamping_devices
Z1870037	Sample holder L standard Ø 40 mm closed, Clamping_devices, Precision_clamping_devices
Z1870039	Sample holder L Flex Ø 40 mm, Clamping_devices, Precision_clamping_devices
Z1870043	Sample holder L parallel clamping vice open, Clamping_devices, Precision_clamping_devices
Z1870041	Sample holder L parallel clamping vice closed, Clamping_devices, Precision_clamping_devices
Z1870045	Drop shape sample holder L Ø 40 mm, Clamping_devices, Precision_clamping_devices
Z1870047	Universal clamping vice L, Clamping_devices, Precision_clamping_devices
Z1870049	Matrix clamping vice L, Clamping_devices, Precision_clamping_devices
Z1870054	Mini vice L, Clamping_devices, Precision_clamping_devices
Z1870056	Double parallel vice L, Clamping_devices, Precision_clamping_devices
Z1870058	Adaptor with ball joint L, Clamping_devices, Precision_clamping_devices
Z1870064	Reduction ring Ø 25 mm, Clamping_devices, Precision_clamping_devices
Z1870063	Reduction ring Ø 30 mm, Clamping_devices, Precision_clamping_devices
Z1870071	Reduction ring Ø 40 mm, Clamping_devices, Precision_clamping_devices
Z1870067	Reduction ring 1", Clamping_devices, Precision_clamping_devices
Z1870066	Reduction ring 1 1/4", Clamping_devices, Precision_clamping_devices
Z1870065	Reduction ring 1 1/2", Clamping_devices, Precision_clamping_devices
Z1870068	Manual chuck Ø 32 mm, Clamping_devices, Precision_clamping_devices
Z1870069	Manual chuck Ø 44 mm, Clamping_devices, Precision_clamping_devices
Z1870070	Manual chuck Ø 56 mm, Clamping_devices, Precision_clamping_devices

VACUUM CLAMPING VICES, CLAMPING_DEVICES, PRECISION_CLAMPING_DEVICES

Z1870028	Vacuum sample holder, Clamping_devices, Precision_clamping_devices
01870288	Vacuum holder (sacrificial plate), Clamping_devices, Precision_clamping_devices
Z1304600	Vacuum pump 230V/50Hz for vacuum sample holder, Clamping_devices, Precision_clamping_devices
Z1304634	Vacuum pump 110V/60Hz for vacuum sample holder, Clamping_devices, Precision_clamping_devices

QUICK CLAMPING TOOLS, CLAMPING_DEVICES

QTOOL 60, CLAMPING_DEVICES, QTOOL_SERIES

Z2235200	Qtool 60, Clamping_devices, Qtool_series
02235202	Clamping jaw 32 mm - for Qtool 60, Clamping_devices, Qtool_series
Z2235201	Clamping jaws 60 mm - for Qtool 60, Clamping_devices, Qtool_series
02235212	Clamping jaw 32 mm bevelled - for Qtool 60, Clamping_devices, Qtool_series
02235213	Clamping jaw 32 mm cross prism - for Qtool 60, Clamping_devices, Qtool_series
Z2235202	Clamping jaws 60 mm slotted - for Qtool 60, Clamping_devices, Qtool_series
Z2235203	Clamping jaws 60 mm slotted prism - for Qtool 60, Clamping_devices, Qtool_series

QTOOL 80, CLAMPING_DEVICES, QTOOL_SERIES

Z2231203	Qtool 80 - 100mm, Clamping_devices, Qtool_series
02231243	Clamping jaw 40 mm, Clamping_devices, Qtool_series
Z2231215	Clamping jaws 70 mm, Clamping_devices, Qtool_series
02231245	Clamping jaw 40 mm bevelled, Clamping_devices, Qtool_series
02231246	Clamping jaw 40 mm cross prism, Clamping_devices, Qtool_series
Z2231216	Clamping jaws 70 mm slotted, Clamping_devices, Qtool_series
Z2231217	Clamping jaws 70 mm slotted prism, Clamping_devices, Qtool_series

QTOOL 80 VARIO, CLAMPING_DEVICES, QTOOL_SERIES

Z2231200	Qtool 80 Vario - 100 mm, Clamping_devices, Qtool_series
Z2231210	Workpiece stop, Clamping_devices, Qtool_series

02231200	Clamping jaw, 40 mm - for Qtool 80 Vario, Clamping_devices, Qtool_series
Z2231211	Clamping jaws, 70 mm, Clamping_devices, Qtool_series
02231213	Prism jaw, 40 mm, Clamping_devices, Qtool_series
02231229	Bevelled jaw, 40 mm, Clamping_devices, Qtool_series
02231230	Cross prism jaw, 40 mm, Clamping_devices, Qtool_series
Z2231212	Round bar jaws, 70 mm slotted, Clamping_devices, Qtool_series
Z2231213	Prism jaws, 70 mm slotted, Clamping_devices, Qtool_series
Z2231214	Clamping jaws, 70 mm slotted, Clamping_devices, Qtool_series

EASY-CLAMPING PLATES, CLAMPING_DEVICES, EASY_CLAMPING_PLATES

Z2236030	Easy-clamping plate S, Clamping_devices, Easy_clamping_plates
Z2236031	Easy-clamping plate S with rotating unit, Clamping_devices, Easy_clamping_plates
Z2236035	Easy-clamping plate M, Clamping_devices, Easy_clamping_plates

ACCESSORIES FOR EASY-CLAMPING PLATES

Z2236032	Easy adaption horizontal, Clamping_devices, Easy_clamping_plates
Z2236033	Easy adaption vertical, Clamping_devices, Easy_clamping_plates
Z2236034	Easy adaption Qtool 40 - 60, Clamping_devices, Easy_clamping_plates
Z2236038	Multitower rotating plate, Clamping_devices, Easy_clamping_plates
Z2236039	Multitower, Clamping_devices, Easy_clamping_plates
Z2236040	Swivel unit Qtool 40 - 60, Clamping_devices, Easy_clamping_plates
Z2236036	Easy-multifunctional plate, Clamping_devices, Easy_clamping_plates

CLAMPING ACCESSORIES FOR ROTATING, SWIVELING AND SPECIAL APPLICATIONS, CLAMPING_DEVICES, CLAMPING_ACCESSORIES_SPECIALS

Z2236041	Swivel unit Qtool 60 - 80, Clamping_devices, Clamping_accessories_specials
Z1304643	Screw clamber with Easy-clamping plate M, Clamping_devices, Clamping_accessories_specials
Z1304636	Expansion clamping device, Clamping_devices, Clamping_accessories_specials

Z2236009	Vertical clamp single, Clamping_devices, Clamping_accessories_specials
Z2236010	Vertical clamp double, Clamping_devices, Clamping_accessories_specials
Z2234010	Clamping system X-Clamp 3858, Clamping_devices, Clamping_accessories_specials

CROSS VICES, CLAMPING_DEVICES, CLAMPING_ACCESSORIES_SPECIALS

Z1340010	 Cross vice 50 - 100, Clamping_devices, Clamping_accessories_specials
----------	--

ANGLE AND ROTATING VICES, CLAMPING_DEVICES, CLAMPING_ACCESSORIES_SPECIALS



Z1304001	Angle vice 60, Clamping_devices, Clamping_accessories_specials
01304008	Prism jaw angle vice 60, Clamping_devices, Clamping_accessories_specials

ROTATING DEVICES, CLAMPING_DEVICES, ROTATION_DEVICES

Z1870059	Rotation device type RD1, Clamping_devices, Rotation_devices
Z1891001	Rotation device type RD2.1, Clamping_devices, Rotation_devices

UNIVERSAL VICES AND ACCESSORIES, CLAMPING_DEVICES, UNIVERSAL_VICES_AND_ACCESSORIES

Z1350025	Clamping rail, Clamping_devices, Universal_vices_and_accessories
01350022	Prism 120°, Clamping_devices, Universal_vices_and_accessories
01350023	Prism slim, Clamping_devices, Universal_vices_and_accessories
01350024	Prism 90°, Clamping_devices, Universal_vices_and_accessories
01350025	Prism 90° high, Clamping_devices, Universal_vices_and_accessories
Z1350008	 Universal vice Piccolo 54, Clamping_devices, Universal_vices_and_accessories
Z1350010	 Suitcase set universal vice Piccolo 54, Clamping_devices, Universal_vices_and_accessories
Z1350012	 Universal vice Piccolo 100, Clamping_devices, Universal_vices_and_accessories
Z1350002	 Universal vice Mono 61, Clamping_devices, Universal_vices_and_accessories

Z1350004		Suitcase set universal vice Mono 61, Clamping_devices, Universal_vices_and_accessories
Z1350011		Universal vice Mono 132, Clamping_devices, Universal_vices_and_accessories
Z1350005		Universal vice Duo, Clamping_devices, Universal_vices_and_accessories
Z1350006		Chain vice set, Clamping_devices, Universal_vices_and_accessories
92005796		Longitudinal v-shoe, Clamping_devices, Universal_vices_and_accessories
92005797		Traverse v-shoe, Clamping_devices, Universal_vices_and_accessories
92005799		Longitudinal bridge, Clamping_devices, Universal_vices_and_accessories
92005800		Traverse bridge, Clamping_devices, Universal_vices_and_accessories
92005798		Standard clamping shoe, Clamping_devices, Universal_vices_and_accessories
Z1350007		Height adapter 60mm Piccolo, Clamping_devices, Universal_vices_and_accessories
Z1350003		Height adapter 74mm Mono, Clamping_devices, Universal_vices_and_accessories
95003172		Clamping arm extension Piccolo 54 and Mono 61, Clamping_devices, Universal_vices_and_accessories
Z1304591		Fixing screw M6 x 25, Clamping_devices, Universal_vices_and_accessories
95003169		Fixing screw Piccolo M8 x 25, Clamping_devices, Universal_vices_and_accessories
95003170		Fixing screw Piccolo M10 x 25, Clamping_devices, Universal_vices_and_accessories
95003168		Fixing screw Mono M10 x 32, Clamping_devices, Universal_vices_and_accessories
91001157		T-slot nut - stainless M6 x 8, Clamping_devices, Universal_vices_and_accessories
91001161		T-slot nut - stainless M8 x 10, Clamping_devices, Universal_vices_and_accessories
91001159		T-slot nut - stainless M8 x 12, Clamping_devices, Universal_vices_and_accessories
91001158		T-slot nut - stainless M10 x 12, Clamping_devices, Universal_vices_and_accessories