



切割机

QCUT 250 A

Qcut 250 A 是一款紧凑灵活的半自动砂轮切割机，配有 **254 毫米/10 英寸**切割轮，可切割直径达 **95 毫米**的工件或样品。该机器既有手动切割机的优点和速度，又有自动砂轮切割机的优点。

半自动 Qcut 250 A 配备了手柄和自动手柄制动器，可单手操作，使垂直切割或切割轮定位比以前更容易。带 T 型槽的切割台由不锈钢制成，既可与动态自动驱动装置配合使用（允许脉冲切割），也可在手动模式下通过手轮操作（横向切割）。Qcut 250 A 采用久经考验的 QATM 脉冲切割技术，即使切割最难加工的材料，也能获得出色的切割效果。同时拥有自动 X 轴可在大型工件直切时实现温和切割（摆动式切割）。

对于更复杂的切割任务，Qcut 250 A 可选配自动横向工作台，以执行连续切割。在设置和操作过程中，通过行程测量对各轴进行监控。



[点击观看视频](#)

优点

- | 带有机电操纵杆制动器的手动 Y 轴
- | Care-cut: 助力于温和切割
- | 7 英寸触屏操作界面，直观的 QATM 用户软件控制
- | 自动 X 轴及由手柄实现的手动行程
- | 切割力相关的进给控制（X 轴）
- | 切割室优异的 LED 照明
- | 在切割序列期间，平行设置的切割轮防护罩增加了切割能力
- | 两侧开口用于长工件

性能指标

精细动态切割

通过手动切割运动，切割力通过一组齿轮进行调节。因此，切割时不会出现晃动，而且更加精确。使用方便的操纵杆制动器可将切割轮固定在任何位置。

水平运动

通过手动水平移动或自动移动，可以纵向切割较长的工件，并方便地将样品放置在切割轮下方。在脉冲切割模式下，样品材料被切割得特别平缓。

直观的控制软件

新的控制软件集成了丰富的维护菜单，使操作简单舒适。

自动横移

自动 Z 轴可以 0.1 毫米的精度进行调整，以实现平行切割。

切割机 QCUT 250 A

超凡细节

1. 大尺寸切割试台

- | 轴可以无反弹定位
- | 简洁的凹槽设计，便于 QATM 夹具的安装
- | 用于单独夹具的 12 毫米 T 型槽
- | 最大宽 x 高: 380 mm x 270 mm (不带 Z-axis), 否则 300 mm x 270

2. 人体工学控制面板

- | 10,1" 彩色触摸屏
- | 用于手动操作的操纵杆

3. 激光辅助定位

- | 用于切割前工件的精确定位

4. 切割轮锁定

5. 侧开口

- | 用于切割前工件的精确定位

6. 坚固的外壳

- | 坚固的粉末涂层铝质结构

7. 平行导向的切割轮罩盖

- | 交叉切割能力的提升

8 大型手动操纵杆

- | 带自动锁定制动器的手动操纵杆，用于精确的横向切割



通过锁定机制和简易螺母系统实现简化的切割轮更换操作

完美的切割 - 由QPREP耗材保证

当使用正确的元素: 知识、保养和正确选择耗材和切割机进行加工时, 切割更可靠、更安全、更高效。

快速、强大、灵活-QTOOLS 夹具

我们创新的夹具用于安全、精确地夹紧工件, 以确保精确的切割和磨削过程。针对特定的应用和工件尺寸, 我们已经开发了各种不同的夹具。

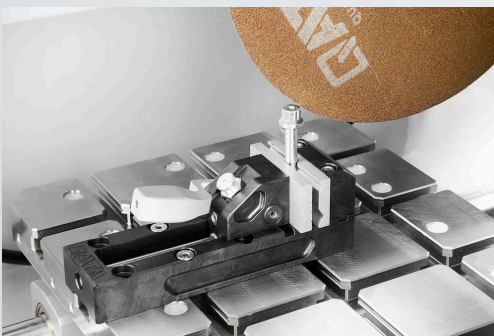

切割机 QCUT 250 A

技术参数

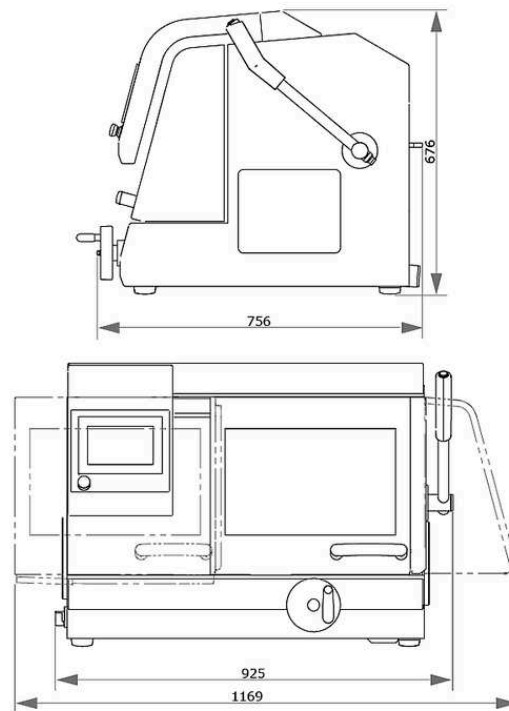

切割轮	可达254mm/10"
最大切割能力	ø 95 mm
X轴 自动 & 手动	225 mm
Y轴行距 手动	170 mm
Z-轴自动 (可选)	120 mm
Z轴精度	0.1 mm
载物台 (不含Z轴) 宽x深	380 x 270 mm
载物台 (含Z轴) 宽x深	300 x 270 mm
T型槽	12 mm
连接电源	5.5 kVA
工作功率 (主载荷)	3 kW, S1; 4 kW, S3/60%
转速	3015 rpm at 50Hz and 3100 rpm at 60Hz
宽 x 高 x 深	925 x 676 x 756 mm
重量 (取决于设备)	~ 130 kg

www.qatm.cn/qcut-250-a

ORDER DATA

BASIC EQUIPMENT

MACHINE (ALL ITEMS REQUIRED)

M1822000		Qcut 250 A (Brillant 240) Base machine
----------	---	--







POWER SUPPLY (1 ITEM REQUIRED)



A1822001	Qcut 250 A power connection 400V/50Hz (3Ph/PE)
A1822002	Qcut 250 A power connection 480V/60Hz (3Ph/PE)
A1822003	Qcut 250 A power connection 220V/60Hz (3Ph/PE)

TABLE DRIVE BRILLANT (1 ITEM REQUIRED)



A1822004	Qcut 250 A X-Axis aut.&manual / without Z-Axis
A1822005	Qcut 250 A X-Axis aut.&manual / Z-Axis aut.

RECIRCULATION SYSTEM (1 ITEM REQUIRED)

A5800484		Recirculation Cooling System 45L 400V/50Hz (3Ph/PE) mobile, with insertion mechanism
A5800485		Recirculation Cooling System 45L 480V/60Hz (3Ph/PE) mobile, with insertion mechanism
A5800486		Recirculation Cooling System 45L 220V/60Hz (3Ph/PE) mobile, with insertion mechanism
A5800487		Recirculation Cooling System 45L 400V/50Hz (3Ph/PE) mobile, without folding wheels
A5800488		Recirculation Cooling System 45L 480V/60Hz (3Ph/PE) mobile, without folding wheels
A5800489		Recirculation Cooling System 45L 220V/60Hz (3Ph/PE) mobile, without folding wheels
A6501009		Belt filter 130 - 400V/50Hz (3Ph/PE)

A6501011		Belt filter 130 - 480V/60Hz (3Ph/PE)
A6501010		Belt filter 130 - 220V/60Hz (3Ph/PE)
Z6501004		Connection set belt filter 130

OPTIONS (TO BE ORDERED WITH MACHINE)

A1822006		Qcut 250 A laser alignment aid
A1822007		Qcut 250 A centrifugal separator 400V 50Hz/480V 60Hz
A1822008		Qcut 250 A centrifugal separator 220V 60Hz

PRECISION CLAMPING DEVICES, CLAMPING_DEVICES, PRECISION_CLAMPING_DEVICES

Z1870035		Sample holder L standard Ø 40 mm open, Clamping_devices, Precision_clamping_devices
Z1870037		Sample holder L standard Ø 40 mm closed, Clamping_devices, Precision_clamping_devices
Z1870039		Sample holder L Flex Ø 40 mm, Clamping_devices, Precision_clamping_devices
Z1870043		Sample holder L parallel clamping vice open, Clamping_devices, Precision_clamping_devices
Z1870041		Sample holder L parallel clamping vice closed, Clamping_devices, Precision_clamping_devices
Z1870045		Drop shape sample holder L Ø 40 mm, Clamping_devices, Precision_clamping_devices
Z1870047		Universal clamping vice L, Clamping_devices, Precision_clamping_devices
Z1870049		Matrix clamping vice L, Clamping_devices, Precision_clamping_devices
Z1870054		Mini vice L, Clamping_devices, Precision_clamping_devices
Z1870056		Double parallel vice L, Clamping_devices, Precision_clamping_devices
Z1870058		Adaptor with ball joint L, Clamping_devices, Precision_clamping_devices
Z1870064		Reduction ring Ø 25 mm, Clamping_devices, Precision_clamping_devices
Z1870063		Reduction ring Ø 30 mm, Clamping_devices, Precision_clamping_devices

Z1870071	Reduction ring Ø 40 mm, Clamping_devices, Precision_clamping_devices
Z1870067	Reduction ring 1", Clamping_devices, Precision_clamping_devices
Z1870066	Reduction ring 1 1/4", Clamping_devices, Precision_clamping_devices
Z1870065	Reduction ring 1 1/2", Clamping_devices, Precision_clamping_devices
Z1870068	Manual chuck Ø 32 mm, Clamping_devices, Precision_clamping_devices
Z1870069	Manual chuck Ø 44 mm, Clamping_devices, Precision_clamping_devices
Z1870070	Manual chuck Ø 56 mm, Clamping_devices, Precision_clamping_devices

VACUUM CLAMPING VICES, CLAMPING_DEVICES, PRECISION_CLAMPING_DEVICES

Z1870028	Vacuum sample holder, Clamping_devices, Precision_clamping_devices
01870288	Vacuum holder (sacrificial plate), Clamping_devices, Precision_clamping_devices
Z1304600	Vacuum pump 230V/50Hz for vacuum sample holder, Clamping_devices, Precision_clamping_devices
Z1304634	Vacuum pump 110V/60Hz for vacuum sample holder, Clamping_devices, Precision_clamping_devices

QUICK CLAMPING TOOLS, CLAMPING_DEVICES

QTOOL 60, CLAMPING_DEVICES, QTOOL_SERIES

Z2235200	Qtool 60, Clamping_devices, Qtool_series
02235202	Clamping jaw 32 mm - for Qtool 60, Clamping_devices, Qtool_series
Z2235201	Clamping jaws 60 mm - for Qtool 60, Clamping_devices, Qtool_series
02235212	Clamping jaw 32 mm bevelled - for Qtool 60, Clamping_devices, Qtool_series
02235213	Clamping jaw 32 mm cross prism - for Qtool 60, Clamping_devices, Qtool_series
Z2235202	Clamping jaws 60 mm slotted - for Qtool 60, Clamping_devices, Qtool_series
Z2235203	Clamping jaws 60 mm slotted prism - for Qtool 60, Clamping_devices, Qtool_series

QTOOL 80, CLAMPING_DEVICES, QTOOL_SERIES

Z2231203	Qtool 80 - 100mm, Clamping_devices, Qtool_series
02231243	Clamping jaw 40 mm, Clamping_devices, Qtool_series
Z2231215	Clamping jaws 70 mm, Clamping_devices, Qtool_series
02231245	Clamping jaw 40 mm bevelled, Clamping_devices, Qtool_series

02231246	Clamping jaw 40 mm cross prism, Clamping_devices, Qtool_series
Z2231216	Clamping jaws 70 mm slotted, Clamping_devices, Qtool_series
Z2231217	Clamping jaws 70 mm slotted prism, Clamping_devices, Qtool_series

QTOOL 80 VARIO, CLAMPING_DEVICES, QTOOL_SERIES

Z2231200	Qtool 80 Vario - 100 mm, Clamping_devices, Qtool_series
Z2231210	Workpiece stop, Clamping_devices, Qtool_series
02231200	Clamping jaw, 40 mm - for Qtool 80 Vario, Clamping_devices, Qtool_series
Z2231211	Clamping jaws, 70 mm, Clamping_devices, Qtool_series
02231213	Prism jaw, 40 mm, Clamping_devices, Qtool_series
02231229	Bevelled jaw, 40 mm, Clamping_devices, Qtool_series
02231230	Cross prism jaw, 40 mm, Clamping_devices, Qtool_series
Z2231212	Round bar jaws, 70 mm slotted, Clamping_devices, Qtool_series
Z2231213	Prism jaws, 70 mm slotted, Clamping_devices, Qtool_series
Z2231214	Clamping jaws, 70 mm slotted, Clamping_devices, Qtool_series

EASY-CLAMPING PLATES, CLAMPING_DEVICES, EASY_CLAMPING_PLATES

Z2236030	Easy-clamping plate S, Clamping_devices, Easy_clamping_plates
Z2236031	Easy-clamping plate S with rotating unit, Clamping_devices, Easy_clamping_plates
Z2236035	Easy-clamping plate M, Clamping_devices, Easy_clamping_plates

ACCESSORIES FOR EASY-CLAMPING PLATES

Z2236032	Easy adaption horizontal, Clamping_devices, Easy_clamping_plates
Z2236033	Easy adaption vertical, Clamping_devices, Easy_clamping_plates
Z2236034	Easy adaption Qtool 40 - 60, Clamping_devices, Easy_clamping_plates
Z2236038	Multitower rotating plate, Clamping_devices, Easy_clamping_plates
Z2236039	Multitower, Clamping_devices, Easy_clamping_plates
Z2236040	Swivel unit Qtool 40 - 60, Clamping_devices, Easy_clamping_plates
Z2236036	Easy-multifunctional plate, Clamping_devices, Easy_clamping_plates

CLAMPING ACCESSORIES FOR ROTATING, SWIVELING AND SPECIAL APPLICATIONS, CLAMPING_DEVICES, CLAMPING_ACCESSORIES_SPECIALS

Z2236041	Swivel unit Qtool 60 - 80, Clamping_devices, Clamping_accessories_specials
Z1304643	Screw clamber with Easy-clamping plate M, Clamping_devices, Clamping_accessories_specials
Z1304636	Expansion clamping device, Clamping_devices, Clamping_accessories_specials
Z2236009	Vertical clamp single, Clamping_devices, Clamping_accessories_specials
Z2236010	Vertical clamp double, Clamping_devices, Clamping_accessories_specials
Z2234010	Clamping system X-Clamp 3858, Clamping_devices, Clamping_accessories_specials

CROSS VICES, CLAMPING_DEVICES, CLAMPING_ACCESSORIES_SPECIALS

Z1340010	 Cross vice 50 - 100, Clamping_devices, Clamping_accessories_specials
----------	---

ANGLE AND ROTATING VICES, CLAMPING_DEVICES, CLAMPING_ACCESSORIES_SPECIALS





Z1304001	Angle vice 60, Clamping_devices, Clamping_accessories_specials
01304008	Prism jaw angle vice 60, Clamping_devices, Clamping_accessories_specials

ROTATING DEVICES, CLAMPING_DEVICES, ROTATION_DEVICES

Z1870059	Rotation device type RD1, Clamping_devices, Rotation_devices
Z1891001	Rotation device type RD2.1, Clamping_devices, Rotation_devices

UNIVERSAL VICES AND ACCESSORIES, CLAMPING_DEVICES, UNIVERSAL_VICES_AND_ACCESSORIES

01350022	Prism 120°, Clamping_devices, Universal_vices_and_accessories
01350023	Prism slim, Clamping_devices, Universal_vices_and_accessories
01350024	Prism 90°, Clamping_devices, Universal_vices_and_accessories
01350025	Prism 90° high, Clamping_devices, Universal_vices_and_accessories
Z1350008	 Universal vice Piccolo 54, Clamping_devices, Universal_vices_and_accessories

Z1350010		Suitcase set universal vice Piccolo 54, Clamping_devices, Universal_vices_and_accessories
Z1350012		Universal vice Piccolo 100, Clamping_devices, Universal_vices_and_accessories
Z1350002		Universal vice Mono 61, Clamping_devices, Universal_vices_and_accessories
Z1350004		Suitcase set universal vice Mono 61, Clamping_devices, Universal_vices_and_accessories
Z1350011		Universal vice Mono 132, Clamping_devices, Universal_vices_and_accessories
Z1350005		Universal vice Duo, Clamping_devices, Universal_vices_and_accessories
Z1350006		Chain vice set, Clamping_devices, Universal_vices_and_accessories
92005796		Longitudinal v-shoe, Clamping_devices, Universal_vices_and_accessories
92005797		Traverse v-shoe, Clamping_devices, Universal_vices_and_accessories
92005799		Longitudinal bridge, Clamping_devices, Universal_vices_and_accessories
92005800		Traverse bridge, Clamping_devices, Universal_vices_and_accessories
92005798		Standard clamping shoe, Clamping_devices, Universal_vices_and_accessories
Z1350007		Height adapter 60mm Piccolo, Clamping_devices, Universal_vices_and_accessories
Z1350003		Height adapter 74mm Mono, Clamping_devices, Universal_vices_and_accessories
95003172		Clamping arm extension Piccolo 54 and Mono 61, Clamping_devices, Universal_vices_and_accessories
Z1304591		Fixing screw M6 x 25, Clamping_devices, Universal_vices_and_accessories
95003169		Fixing screw Piccolo M8 x 25, Clamping_devices, Universal_vices_and_accessories
95003170		Fixing screw Piccolo M10 x 25, Clamping_devices, Universal_vices_and_accessories
95003168		Fixing screw Mono M10 x 32, Clamping_devices, Universal_vices_and_accessories
91001157		T-slot nut - stainless M6 x 8, Clamping_devices, Universal_vices_and_accessories
91001161		T-slot nut - stainless M8 x 10, Clamping_devices, Universal_vices_and_accessories
91001159		T-slot nut - stainless M8 x 12, Clamping_devices, Universal_vices_and_accessories
91001158		T-slot nut - stainless M10 x 12, Clamping_devices, Universal_vices_and_accessories