



精密切割机

QCUT 200 A



## 精密切割机 QCUT 200 A

### 性能指标

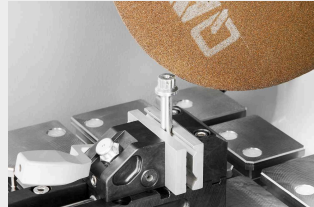

#### 对安全的最高要求

- | 由于采用了使能开关，当切割室门打开时，设备只能通过双手控制定位。
- | 这为机器操作人员消除了挤压风险

#### 智能工件探测

- | 除了经过验证的自动工件探测功能外，本机还具有新型的退出检测（自动停止功能）。
- | 自动检测切割过程的起点和终点，缩短过程时间。

#### 凭借坚固的设计，实现了最高的精度

- | 受益于稳固的结构，机器具有耐用性和低振动特性
- | 以最高的精度对精细样品进行切割或磨削（使用研磨杯轮）
- | 由于有大型滑动门，使用切割室非常方便
- | 可在大切割试台上快速、安全地安装各种类型的夹具

#### 直观极简的操作

- | 大7英寸工业触屏，配有符合人体工程学的用户操作指南
- | 用户友好的软件易于操作
- | 使用操纵杆，可实现自动轴的舒适移动

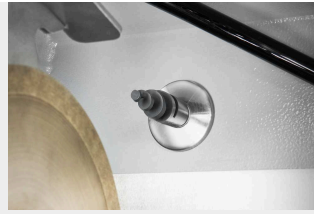

### 流量监控

- | 通过可选的流量监控，在长时间切割敏感样品时，可以确保持续冷却。
- | 当达到临界阈值时，切割过程自动中断

### 自动清洗功能

- | 归功于位于切割室内的螺旋喷嘴，可实现全自动清洗
- | 清洗可以单独打开，如果需要，可以在每次切割后自动启动
- | 切割过程中的清晰观察：自动清洗也可以在切割操作期间激活

### 广泛的切割程序

- | 根据工件的几何形状，可采用横向或纵向切割来减少工件和切割轮之间的接触面积
- | 通过步进切割将工件一层一层地切开，并优化动作角度-特别适合固体物料

此仪器是地质学及矿物学应用的理想选择

## 精密切割机 QCUT 200 A 不受限制的切割

### 1. 切割室冲洗

### 5. 附件

切割室自动清洗

## 2. 大切割台

- | 轴可以无反弹定位
- | 简洁的凹槽设计，便于QATM夹具的安装
- | 8毫米T型槽用于单独的夹持装置
- | 最大尺寸 长 x 宽: 300 mm x 210 mm

## 3. 人体工学控制面板

- | 大 7" TFT 触屏显示
- | 用于手动操作的操纵杆

## 4. 激光辅助定位

- | 用于切割前工件的精确定位
- | 作为标准配置包括在内

通过转动装置或进一步的夹紧装置单独扩展夹持可能性

## 6. 切割轮锁定

- | 通过锁定功能简化截割轮更换
- | 带集成润滑选项

## 7. 修刀装置

- | 用于修整金刚石切割轮和研磨杯轮
- | 可以从外部手动操作

## 8. 烟雾分离器

- | 有效去除切割过程中的冷却剂水雾



QCUT150A和200A适用的最佳配件

## 循环冷却系统

在切割过程中，最佳的冷却措施至关重要。切割过程中若热量过大，会损伤样品并增加切割轮的磨损。冷却和防腐保护剂能够散热，并同时清除切割室内的碎屑。



**15L循环冷却系统**

- | 带过滤筒和盖子的便携式系统
- | 占地面积小
- | 易于集成到现有实验室家具中
- | 双室过滤系统



**45L循环冷却系统（移动式）**

- | 带进水滤网、过滤袋和溢流管的移动式单元
- | 可以放在实验室工作台下面，或者落地柜中
- | 可通过选配泵模块扩展用于切割室冲洗
- | 双室过滤系统，带可拆卸分离滑块



**45L循环冷却系统（系统实验室）**

- | 带伸缩机构的移动式装置
- | 可以很方便地集成到QATM系统实验室柜和带下架的橱柜中
- | 可通过选配泵模块扩展用于切割室冲洗
- | 带进水滤网、过滤袋和溢流管
- | 双室过滤系统，带可拆卸分离滑块

附件配件

## 夹具

使用易夹持系统，可以将夹具简单、牢固地固定到工作台上，只需一个螺丝。这样就不必冗长地在工作台T型槽中固定夹具了。易夹持系统是一个创新的补充，对日常工作很有裨益。



易夹持系统底座 S 带旋转功能 + 易适应功能 (垂直)

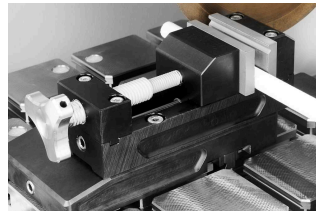

易夹持底座 S 带Qtool 40 S

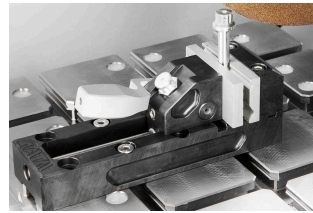

Qtool 40



[点击观看视频](#)

Clamping and cutting  
of challenging samples  
(视频)

### 完美的切割 - 由QPREP耗材保证

当使用正确的元素: 知识、保养和正确选择耗材和切割机进行加工时, 切割更可靠、更安全、更高效。Qprep系列产品包含了专门针对多种材料和不同需求而研发的切割轮。

- | 在切割过程中, 降低对试件的热影响
- | 湿式砂轮切割完成后, 能获得非常精细的表面效果
- | 理想的切割可缩短后续的制备步骤



### 精密夹具

QATM的精密系列为常规和不规则形状的样品提供了多种夹持方式, 专为苛刻和精密的金相应用而设计。

- | 处理不规则和复杂几何形状样品
- | 丰富多样的产品系列
- | 可与旋转装置集成 (Qcut 150 A)
- | 可实现水平和垂直适应



精密切割机 QCUT 200 A

技术参数

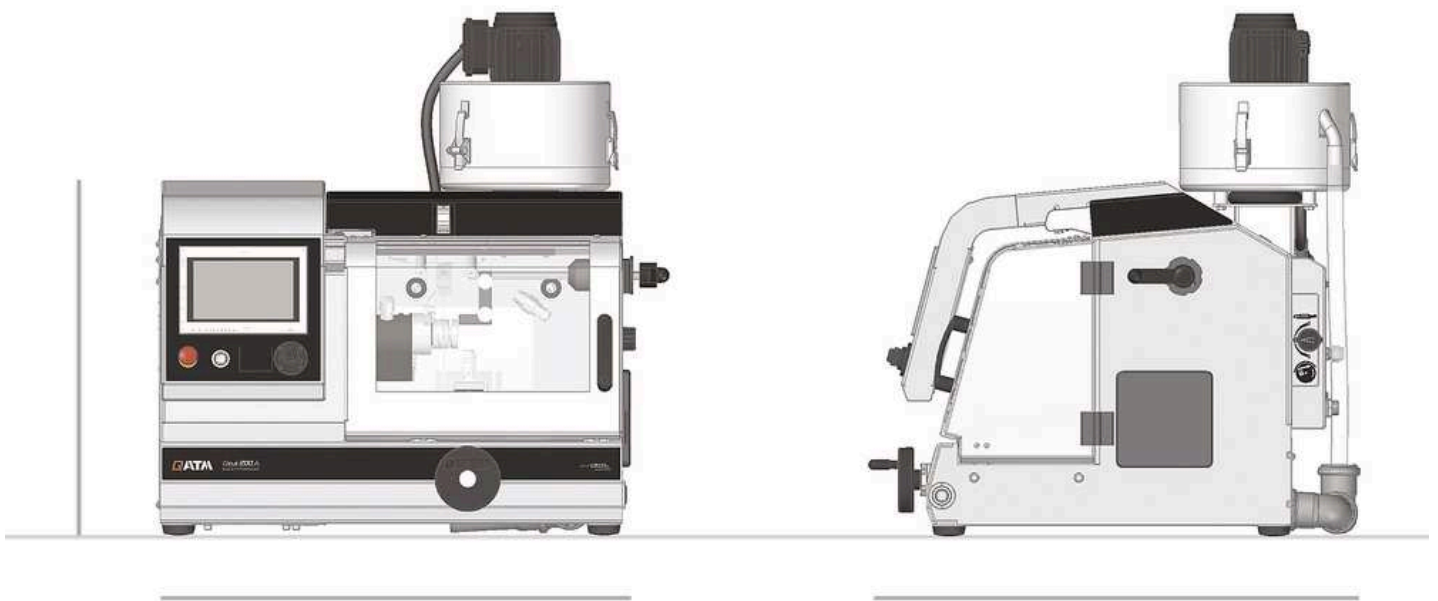

切割轮	up to $\varnothing$ 203 mm / 8"
最大切割能力	75 mm (cut-off wheel $\varnothing$ 200 mm)
切割轮法兰尺寸	$\varnothing$ 12,7 mm
X轴	210 mm (手动/自动)
Y轴	80 mm (自动)
Z轴 (选配)	80 mm (自动)
进给速度	0.01 - 20 mm/s
Z轴精度	0,005 mm
最小交叉进给 (Z轴)	0,001 mm
不含Z轴的工作台 (WxD)	300 x 210 mm
带Z轴的工作台 (WxD)	280 x 210 mm
T型槽	8 mm

转速	300 - 5000 rpm
工作功率 (主载荷)	0,75 kW, S1
连接电源	2,2 kVA
宽 x 高 x 深	725 x 535 x 675 mm
重量	~ 82 kg

[www.qatm.cn/qcut-200-a](http://www.qatm.cn/qcut-200-a)

## ORDER DATA

### BASIC EQUIPMENT

#### MACHINE (1 ITEM REQUIRED)

M1891000  Qcut 200 A Base machine 200-240V, 50/60Hz

M1891001  Qcut 200 A Base machine 100-120V, 50/60Hz

#### CROSS FEED (1 ITEM REQUIRED)

A1891000 Qcut 200 A automatic X, Y axis

A1891001 Qcut 200 A automatic X, Y, Z axis

### OPTIONS (TO BE ORDERED WITH MACHINE)

A1891003 Qcut 200 A cutting chamber cleaning

A1891004 Qcut 200 A flow monitoring

A1891005 Qcut 200 A preparation rotation device

Z1891000 Qcut 200 A dressing device

A1891008 Preparation centrifugal separator

Z1891006 Centrifugal separator

A1891002 Preparation fresh water cooling system

#### RECIRCULATION SYSTEM (1 ITEM REQUIRED)

Z5800011 Qcut 200 A recirculation cooling system 15 Ltr.

Z5800012 Qcut 200 A recirculation cooling system 45 Ltr., mobile

Z5800013 Qcut 200 A recirculation cooling system 45 Ltr., for system lab

Z5800014 Pump module recirculation cooling

Z5800015 Pump module chamber cleaning (not usable with cooling system 15 Ltr.)

### OPTIONS (CAN BE ORDERED SEPARATELY)

Z1800002



Sample collector

Z1891001 Rotation device type RD2.1

Z1870050 Flange set Ø 59 mm

Z1870051 Flange set Ø 99 mm

Z1870052 Flange set Ø 139 mm

## PRECISION CLAMPING DEVICES, CLAMPING\_DEVICES, PRECISION\_CLAMPING\_DEVICES

Z1870035 Sample holder L standard Ø 40 mm open, Clamping\_devices,  
Precision\_clamping\_devices

Z1870037 Sample holder L standard Ø 40 mm closed, Clamping\_devices,  
Precision\_clamping\_devices

Z1870039 Sample holder L Flex Ø 40 mm, Clamping\_devices, Precision\_clamping\_devices

Z1870043 Sample holder L parallel clamping vice open, Clamping\_devices,  
Precision\_clamping\_devices

Z1870041 Sample holder L parallel clamping vice closed, Clamping\_devices,  
Precision\_clamping\_devices

Z1870045 Drop shape sample holder L Ø 40 mm, Clamping\_devices,  
Precision\_clamping\_devices

Z1870047 Universal clamping vice L, Clamping\_devices, Precision\_clamping\_devices

Z1870054 Mini vice L, Clamping\_devices, Precision\_clamping\_devices

Z1870056 Double parallel vice L, Clamping\_devices, Precision\_clamping\_devices

Z1870058 Adaptor with ball joint L, Clamping\_devices, Precision\_clamping\_devices

Z1870064 Reduction ring Ø 25 mm, Clamping\_devices, Precision\_clamping\_devices

Z1870063 Reduction ring Ø 30 mm, Clamping\_devices, Precision\_clamping\_devices

Z1870071 Reduction ring Ø 40 mm, Clamping\_devices, Precision\_clamping\_devices

Z1870067 Reduction ring 1", Clamping\_devices, Precision\_clamping\_devices

Z1870066 Reduction ring 1 1/4", Clamping\_devices, Precision\_clamping\_devices

Z1870065 Reduction ring 1 1/2", Clamping\_devices, Precision\_clamping\_devices

Z1870068 Manual chuck Ø 32 mm, Clamping\_devices, Precision\_clamping\_devices

Z1870069 Manual chuck Ø 44 mm, Clamping\_devices, Precision\_clamping\_devices

Z1870070 Manual chuck Ø 56 mm, Clamping\_devices, Precision\_clamping\_devices

#### VACUUM CLAMPING VICES, CLAMPING\_DEVICES, PRECISION\_CLAMPING\_DEVICES

Z1870028 Vacuum sample holder, Clamping\_devices, Precision\_clamping\_devices

01870288 Vacuum holder (sacrificial plate), Clamping\_devices, Precision\_clamping\_devices

Z1304600 Vacuum pump 230V/50Hz for vacuum sample holder, Clamping\_devices, Precision\_clamping\_devices

Z1304634 Vacuum pump 110V/60Hz for vacuum sample holder, Clamping\_devices, Precision\_clamping\_devices

## QUICK CLAMPING TOOLS, CLAMPING\_DEVICES

#### QTOOL 40, CLAMPING\_DEVICES, QTOOL\_SERIES

Z2270201 Qtool 40 S, Clamping\_devices, Qtool\_series

Z2270200 Qtool 40, Clamping\_devices, Qtool\_series

02270202 Clamping jaw 25 mm - for Qtool 40, Clamping\_devices, Qtool\_series

Z2270202 Clamping jaws 45 mm - for Qtool 40, Clamping\_devices, Qtool\_series

02270212 Clamping jaw 25 mm bevelled - for Qtool 40, Clamping\_devices, Qtool\_series

02270213 Clamping jaw 25 mm cross prism - for Qtool 40, Clamping\_devices, Qtool\_series

Z2270203 Clamping jaws 45 mm slotted - for Qtool 40, Clamping\_devices, Qtool\_series

Z2270204 Clamping jaws 45 mm slotted prism - for Qtool 40, Clamping\_devices, Qtool\_series

#### QTOOL 60, CLAMPING\_DEVICES, QTOOL\_SERIES

Z2235200 Qtool 60, Clamping\_devices, Qtool\_series

02235202 Clamping jaw 32 mm - for Qtool 60, Clamping\_devices, Qtool\_series

Z2235201 Clamping jaws 60 mm - for Qtool 60, Clamping\_devices, Qtool\_series

02235212 Clamping jaw 32 mm bevelled - for Qtool 60, Clamping\_devices, Qtool\_series

02235213 Clamping jaw 32 mm cross prism - for Qtool 60, Clamping\_devices, Qtool\_series

Z2235202 Clamping jaws 60 mm slotted - for Qtool 60, Clamping\_devices, Qtool\_series

Z2235203 Clamping jaws 60 mm slotted prism - for Qtool 60, Clamping\_devices, Qtool\_series

## EASY-CLAMPING PLATES, CLAMPING\_DEVICES,

## EASY\_CLAMPING\_PLATES

Z2236030	Easy-clamping plate S, Clamping_devices, Easy_clamping_plates
Z2236031	Easy-clamping plate S with rotating unit, Clamping_devices, Easy_clamping_plates
Z2236035	Easy-clamping plate M, Clamping_devices, Easy_clamping_plates

## ACCESSORIES FOR EASY-CLAMPING PLATES



Z2236032	Easy adaption horizontal, Clamping_devices, Easy_clamping_plates
Z2236033	Easy adaption vertical, Clamping_devices, Easy_clamping_plates
Z2236034	Easy adaption Qtool 40 - 60, Clamping_devices, Easy_clamping_plates
Z2236038	Multitower rotating plate, Clamping_devices, Easy_clamping_plates
Z2236039	Multitower, Clamping_devices, Easy_clamping_plates
Z2236040	Swivel unit Qtool 40 - 60, Clamping_devices, Easy_clamping_plates
Z2236036	Easy-multifunctional plate, Clamping_devices, Easy_clamping_plates

## CLAMPING ACCESSORIES FOR ROTATING, SWIVELING AND SPECIAL APPLICATIONS, CLAMPING\_DEVICES, CLAMPING\_ACCESSORIES\_SPECIALS

Z1304643	Screw clamber with Easy-clamping plate M, Clamping_devices, Clamping_accessories_specials
Z1304636	Expansion clamping device, Clamping_devices, Clamping_accessories_specials
Z2236009	Vertical clamp single, Clamping_devices, Clamping_accessories_specials
Z2236010	Vertical clamp double, Clamping_devices, Clamping_accessories_specials
Z2234010	Clamping system X-Clamp 3858, Clamping_devices, Clamping_accessories_specials

## UNIVERSAL VICES AND ACCESSORIES, CLAMPING\_DEVICES, UNIVERSAL\_VICES\_AND\_ACCESSORIES

01350022	Prism 120°, Clamping_devices, Universal_vices_and_accessories
01350023	Prism slim, Clamping_devices, Universal_vices_and_accessories
01350024	Prism 90°, Clamping_devices, Universal_vices_and_accessories

Z1350008		Universal vice Piccolo 54, Clamping_devices, Universal_vices_and_accessories
Z1350010		Suitcase set universal vice Piccolo 54, Clamping_devices, Universal_vices_and_accessories
Z1350012		Universal vice Piccolo 100, Clamping_devices, Universal_vices_and_accessories
92005796		Longitudinal v-shoe, Clamping_devices, Universal_vices_and_accessories
92005797		Traverse v-shoe, Clamping_devices, Universal_vices_and_accessories
92005799		Longitudinal bridge, Clamping_devices, Universal_vices_and_accessories
92005800		Traverse bridge, Clamping_devices, Universal_vices_and_accessories
92005798		Standard clamping shoe, Clamping_devices, Universal_vices_and_accessories
Z1350007		Height adapter 60mm Piccolo, Clamping_devices, Universal_vices_and_accessories
Z1350003		Height adapter 74mm Mono, Clamping_devices, Universal_vices_and_accessories
95003172		Clamping arm extension Piccolo 54 and Mono 61, Clamping_devices, Universal_vices_and_accessories
Z1304591		Fixing screw M6 x 25, Clamping_devices, Universal_vices_and_accessories
95003169		Fixing screw Piccolo M8 x 25, Clamping_devices, Universal_vices_and_accessories
95003170		Fixing screw Piccolo M10 x 25, Clamping_devices, Universal_vices_and_accessories
95003168		Fixing screw Mono M10 x 32, Clamping_devices, Universal_vices_and_accessories
91001157		T-slot nut - stainless M6 x 8, Clamping_devices, Universal_vices_and_accessories
91001161		T-slot nut - stainless M8 x 10, Clamping_devices, Universal_vices_and_accessories
91001159		T-slot nut - stainless M8 x 12, Clamping_devices, Universal_vices_and_accessories
91001158		T-slot nut - stainless M10 x 12, Clamping_devices, Universal_vices_and_accessories