



切割机器人

QCUT 600 BOT

切割机器人 QCUT 600 BOT

超凡细节

1. 符合人体工程学的控制面板

- | 12.1英寸大型工业触摸屏，配备有直观的QATM 用户软件
- | 快速设置，通过两个操纵杆即可控制所有轴
- | 滑动式控制面板能够提供畅通无阻的工作环境

2. 坚固的机体

- | 坚固的粉末涂层钢质结构
- | 集成的循环冷却单元
- | 轴的自动中央润滑

3. 超大圆形切割试台

- | 由不锈钢制成，内部设有纵向和横向的T型槽
- | 使用T型槽工作台或易夹持系统实现复杂工件形状的稳固夹紧
- | 直径: \varnothing 600 mm
- | 承重能力: 多达150 kg
- | 行程: X: 550 mm, Y: 360 mm, Z: 550 mm

4. 大切割室

- | 大型滑动门便于接近且视野清晰
- | 侧开式门，便于接近切割室

5. 优化的旋转臂

- | 高效冷却系统
- | 平行设置的切割轮防护罩增加了切割能力
- | 激光辅助定位功能便于工件定位

6. 旋转轴, B轴

- | 旋转范围 360° ，同时具备C轴旋转 200° 的功能
- | 定位精度: $\pm 0.1^\circ$

7. 可选旋转轴, C轴

- | 旋转范围: 最大 360°
- | 可移除式模块化旋转轴
- | 夹持能力可以扩展为使用车床卡盘或者其他夹紧装置



轻松进件

用于大型工件

大型工件可直接由叉车或起重机通过宽大的滑动门放入



切割机器人 QCUT 600 BOT

在五维空间中，从大件中切割出小件

凭借专利的5轴技术，工件可以在任何角度进行精确、重复、快速且轻松的切割。所有轴均可精细调节，在切割过程中保持无振动 – 精确切割比以往任何时候都更容易。各轴的定位能力/移动与夹具系统相结合，能够对工件进行精确切割，无需耗时地重新夹紧工件。所有必要的切割操作都可以依次自动完成 – 即使是大型工件也是如此。

1. Y-轴 (垂直切割)

- | 切割范围: 360 mm, 自动
- | Rapid traverse up to 80 mm/s.

2. Z-轴 (交叉进给)

- | 行程: 550 mm, 自动
- | 交叉进给以实现序列操作中的精确平行切割

3. B-轴(旋转轴)

- | 旋转范围：最大360°，组合C轴后200°，自动
- | 定位精度: $\pm 0.1^\circ$

4. X-轴 (水平切割)

- | 切割范围: 550 mm, 自动
- | 快速移动速度可达 80 mm/s。

5. C-轴 (旋转轴)

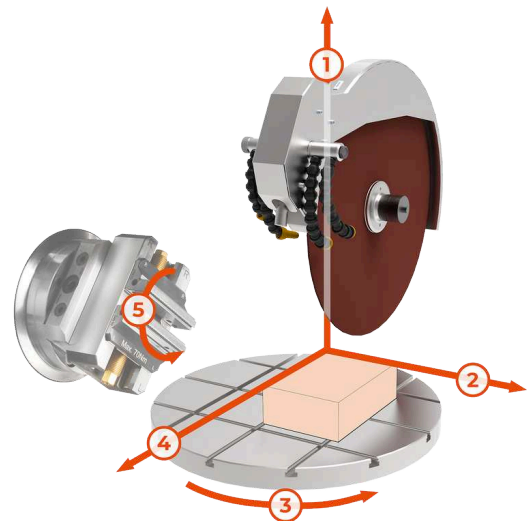

切割机器人 QCUT 600 BOT

性能指标



不锈钢旋转试台

宽敞的旋转工作台（直径 600 毫米）能够在重承载情况下仍实现精确操作。

- Rotation of the machine table (max. 360°) eliminates the need for time-consuming re-clamping of workpieces
- 可通过配备模块化可调节旋转轴（C 轴）进行扩展
- 用于易夹持系统的集成 T 型槽，便于快速安装夹具



自动切割轮测量

动态切割轮测量实现切割质量稳定的可重复的切割结果。

- 自动监控当前切割轮直径
- 每次切割后调整切割参数，
- 使切割速度和切割深度保持恒定



坚固耐用的机器，配有宽敞的切割室

坚固耐用的粉末涂层钢制机身配有大型滑动门，门上装有防刮的夹层安全玻璃，并设有方便的侧向开启门

- 带有可集成循环冷却装置和自动中央润滑系统的机体
- 拥有大型切割室的最优通道设计，并配有安全联锁装置，可防止在切割轮运行时门被打开
- 大型侧门便于更换切割轮



切割优化

为了优化切割质量，机器自动探测局部材料特征点，如硬化区域。

- 基于切割力的进给控制
- 切割探测: 当开始新的切割时，工件被自动检测到，并以低速接近
- 平行引导型切割轮防护罩在直切时增加了切割轮的切割能力

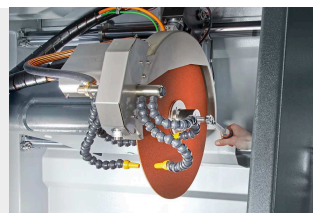
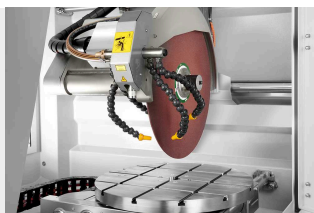

强有力的切割轮驱动

精确的旋转臂导向及切割轮冷却。

- | 水冷式主驱动，驱动功率为 15 千瓦
- | 得益于可灵活调节的冷却管路，实现了最佳冷却效果
- | 平行设置的切割轮防护罩在横向切割时增加了切割能力

直观且易于操作

12.1英寸大型工业触摸屏，配备有直观的QATM 用户软件,操纵杆和急停按钮。

- | 示教功能通过在预期位置的手动定位，实现用户友好的切割位置编程
- | 无须重新夹持即可同时定位和自动切割不同的工件(多点进程功能 MPP)

精妙的设计

简便的切割轮更换和简便的夹持使您能够专注于切割工作。

- | 激光辅助功能，便于工件定位
- | 强力夹紧螺母：便于切割轮的安装与拆卸操作

最大化的易用性

控制面板可移动，并且在机器的安装和使用过程中，可以根据人体工程学原理自由调整其位置。

- | 在靠近工件的位置进行编程操作
- | 在序列操作中，控制面板可以移至一侧

切割机器人 QCUT 600 BOT

附件配件



循环冷却单元

适用于标准应用的紧凑型、集成式冷却系统。

- | 可被集成到机身内并扩展
- | 多室过滤
- | 带有滤袋的进水筛(参考耗材手册)

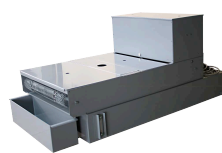

带式过滤系统

用于连续运行的大型冷却和过滤系统，例如在系列化应用中使用。

- | 水箱尺寸: 285 l
- | 过滤能力: 100 l/min (指乳状液)
- | 泵速: 100 l/min



烟雾分离器

工作安全：工作环境空气质量有所改善。

- | 去除冷却剂水雾
- | 净化空气，提高可视性
- | 抽吸功率452 or 500 m3/h 取决于电压

完美的切割 - 由QPREP耗材保证

当使用正确的元素: 知识、保养和正确选择耗材和切割机进行加工时, 切割更可靠、更安全、更高效。Qprep系列产品包含了专门针对多种材料和不同需求而研发的切割轮。

- | 在切割过程中, 降低对试件的热影响
- | 湿式砂轮切割完成后, 能获得非常精细的表面效果
- | 理想的切割可缩短后续的制备步骤



快速、强大、灵活-QTOOLS 夹具

我们创新的夹具用于安全、精确地夹紧工件, 以确保精确的切割和磨削过程。针对特定的应用和工件尺寸, 我们已经开发了各种不同的夹具。

- | 适用于规则和不规则形状样品
- | 快速且重复准确地对规则形状样品进行夹持固定
- | 种类繁多的不同夹具和夹持系统可供选择

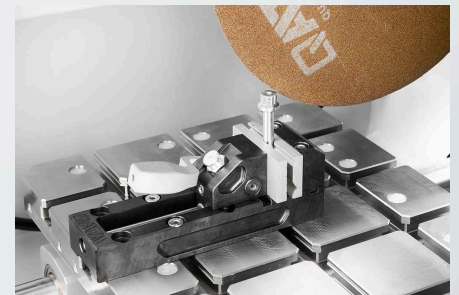

切割机器人 QCUT 600 BOT

技术参数



设备可配置为4轴 (X/Y/Z/B)或5轴(X/Y/Z/B/C)

www.qatm.cn/qcut-600-bot

ORDER DATA

BASIC EQUIPMENT

MACHINE (ALL ITEMS REQUIRED)

M1831001  Qcut 600 BOT (4-axis) base machine 400V 50Hz (3Ph/N/PE)

M1831003  Qcut 600 BOT (5-axis) base machine 400V 50Hz (3Ph/N/PE)

M1831002  Qcut 600 BOT (4-axis) base machine 480V 60Hz (3Ph/PE)

M1831004  Qcut 600 BOT (5-axis) base machine 480V 60Hz (3Ph/PE)

WHEEL GUARD (1 ITEM REQUIRED)

A1831001 Wheel guard 500mm

A1831010 Wheel guard 600mm

RECIRCULATION SYSTEM (1 ITEM REQUIRED)

A1831005  Recirculation cooling system 400V 50Hz (3Ph/PE)

A1831006 Recirculation cooling system 480V 60Hz (3Ph/PE)

A6501000  Belt filter 285 400V 50Hz (3Ph/PE)

A6501002  Belt filter 285 480V 60Hz (3Ph/PE)

Z6501007 Connection set belt filter 285

OPTIONS (TO BE ORDERED WITH MACHINE)

A1831004  Laser alignment aid

A1831007 Centrifugal separator 400V 50Hz (3Ph/PE)

A1831009 Centrifugal separator 480V 60Hz (3Ph/PE)

PRECISION CLAMPING DEVICES, CLAMPING_DEVICES, PRECISION_CLAMPING_DEVICES

Z1870063	Reduction ring Ø 30 mm, Clamping_devices, Precision_clamping_devices
Z1870069	Manual chuck Ø 44 mm, Clamping_devices, Precision_clamping_devices

QUICK CLAMPING TOOLS, CLAMPING_DEVICES

QTOOL 80, CLAMPING_DEVICES, QTOOL_SERIES

Z2231203	Qtool 80 - 100mm, Clamping_devices, Qtool_series
Z2231204	Qtool 80 - 150mm, Clamping_devices, Qtool_series
02231243	Clamping jaw 40 mm, Clamping_devices, Qtool_series
Z2231215	Clamping jaws 70 mm, Clamping_devices, Qtool_series
02231245	Clamping jaw 40 mm bevelled, Clamping_devices, Qtool_series
02231246	Clamping jaw 40 mm cross prism, Clamping_devices, Qtool_series
Z2231216	Clamping jaws 70 mm slotted, Clamping_devices, Qtool_series
Z2231217	Clamping jaws 70 mm slotted prism, Clamping_devices, Qtool_series

QTOOL 80 VARIO, CLAMPING_DEVICES, QTOOL_SERIES

Z2231200	Qtool 80 Vario - 100 mm, Clamping_devices, Qtool_series
Z2231201	Qtool 80 Vario - 150 mm, Clamping_devices, Qtool_series
Z2231202	Qtool 80 Vario - 250 mm, Clamping_devices, Qtool_series
Z2231210	Workpiece stop, Clamping_devices, Qtool_series
02231200	Clamping jaw, 40 mm - for Qtool 80 Vario, Clamping_devices, Qtool_series
Z2231211	Clamping jaws, 70 mm, Clamping_devices, Qtool_series
02231213	Prism jaw, 40 mm, Clamping_devices, Qtool_series
02231229	Bevelled jaw, 40 mm, Clamping_devices, Qtool_series
02231230	Cross prism jaw, 40 mm, Clamping_devices, Qtool_series
Z2231212	Round bar jaws, 70 mm slotted, Clamping_devices, Qtool_series
Z2231213	Prism jaws, 70 mm slotted, Clamping_devices, Qtool_series
Z2231214	Clamping jaws, 70 mm slotted, Clamping_devices, Qtool_series

POWER CLAMPING SYSTEMS, CLAMPING_DEVICES, POWER_CLAMPING_SYSTEMS

POWER CLAMPING SYSTEM 100-540, CLAMPING_DEVICES, POWER_CLAMPING_SYSTEMS

Z2234016	Power clamping system 100-540, Clamping_devices, Power_clamping_systems
Z2234018	Prism clamping jaw, Clamping_devices, Power_clamping_systems
Z2234017	Clamping jaw flat, Clamping_devices, Power_clamping_systems
Z2234019	Angular drive, Clamping_devices, Power_clamping_systems

POWER CLAMPING SYSTEM LC 90, CLAMPING_DEVICES, POWER_CLAMPING_SYSTEMS

Z2234001	Power clamping system LC 90, Clamping_devices, Power_clamping_systems
Z2234003	Carrier jaws LC 90, Clamping_devices, Power_clamping_systems
Z2234004	V-groove jaw 100, Clamping_devices, Power_clamping_systems
Z2234005	Clamping jaw flat, Clamping_devices, Power_clamping_systems
Z2234009	Quick-change adapter, Clamping_devices, Power_clamping_systems
Z2234008	Step jaw 100, Clamping_devices, Power_clamping_systems
Z2234002	Clamping system X-Clamp 100, Clamping_devices, Power_clamping_systems
Z2234006	Socket 90°, Clamping_devices, Power_clamping_systems

EASY-CLAMPING PLATES, CLAMPING_DEVICES, EASY_CLAMPING_PLATES

CLAMPING ACCESSORIES FOR ROTATING, SWIVELING AND SPECIAL APPLICATIONS, CLAMPING_DEVICES, CLAMPING_ACCESSORIES_SPECIALS

Z1304636	Expansion clamping device, Clamping_devices, Clamping_accessories_specials
Z1340000	 Cross vice 80 - 100, Clamping_devices, Clamping_accessories_specials
Z1340001	Cross vice 80 - 150, Clamping_devices, Clamping_accessories_specials



ANGLE AND ROTATING VICES, CLAMPING_DEVICES, CLAMPING_ACCESSORIES_SPECIALS

Z1304001	Angle vice 60, Clamping_devices, Clamping_accessories_specials
01304008	Prism jaw angle vice 60, Clamping_devices, Clamping_accessories_specials
Z1302000	Angle vice 80, Clamping_devices, Clamping_accessories_specials
01302016	Prism jaw angle vice 80, Clamping_devices, Clamping_accessories_specials

ROTATIG DEVICES, CLAMPING_DEVICES, ROTATION_DEVICES

Z1870059	Rotation device type RD1, Clamping_devices, Rotation_devices
Z1891001	Rotation device type RD2.1, Clamping_devices, Rotation_devices

UNIVERSAL VICES AND ACCESSORIES, CLAMPING_DEVICES, UNIVERSAL_VICES_AND_ACCESSORIES

Z1350025	Clamping rail, Clamping_devices, Universal_vices_and_accessories
01350022	Prism 120°, Clamping_devices, Universal_vices_and_accessories
01350023	Prism slim, Clamping_devices, Universal_vices_and_accessories
01350024	Prism 90°, Clamping_devices, Universal_vices_and_accessories
01350025	Prism 90° high, Clamping_devices, Universal_vices_and_accessories
Z1350002	 Universal vice Mono 61, Clamping_devices, Universal_vices_and_accessories
Z1350004	 Suitcase set universal vice Mono 61, Clamping_devices, Universal_vices_and_accessories
Z1350011	 Universal vice Mono 132, Clamping_devices, Universal_vices_and_accessories
Z1350005	Universal vice Duo, Clamping_devices, Universal_vices_and_accessories
Z1350006	Chain vice set, Clamping_devices, Universal_vices_and_accessories
92005796	Longitudinal v-shoe, Clamping_devices, Universal_vices_and_accessories
92005797	Traverse v-shoe, Clamping_devices, Universal_vices_and_accessories
92005799	Longitudinal bridge, Clamping_devices, Universal_vices_and_accessories
92005800	Traverse bridge, Clamping_devices, Universal_vices_and_accessories
92005798	Standard clamping shoe, Clamping_devices, Universal_vices_and_accessories
Z1350007	Height adapter 60mm Piccolo, Clamping_devices, Universal_vices_and_accessories
Z1350003	Height adapter 74mm Mono, Clamping_devices, Universal_vices_and_accessories

95003172	Clamping arm extension Piccolo 54 and Mono 61, Clamping_devices, Universal_vices_and_accessories
Z1304591	Fixing screw M6 x 25, Clamping_devices, Universal_vices_and_accessories
95003169	Fixing screw Piccolo M8 x 25, Clamping_devices, Universal_vices_and_accessories
95003170	Fixing screw Piccolo M10 x 25, Clamping_devices, Universal_vices_and_accessories
95003168	Fixing screw Mono M10 x 32, Clamping_devices, Universal_vices_and_accessories
91001157	T-slot nut - stainless M6 x 8, Clamping_devices, Universal_vices_and_accessories
91001161	T-slot nut - stainless M8 x 10, Clamping_devices, Universal_vices_and_accessories
91001159	T-slot nut - stainless M8 x 12, Clamping_devices, Universal_vices_and_accessories
91001158	T-slot nut - stainless M10 x 12, Clamping_devices, Universal_vices_and_accessories