



振动抛光机

# QPOL VIBRO

???????

**?????? Qpol Vibro ?????????????????????????????????**  
**?????????? EBSD?????????????AFM(??????????????????**  
**??????????????**

???  $\emptyset = 308$  ???  
????????? 21 ???  
????????????? — ??????????????

??  
??



[点击观看视频](#)

## 优点

- | ??????????????????????
- | ??????????????60?120??
- | ???
- | ??????????????????
- | ??????????????????
- | ?????????????????????????????????????
- | ???????????
- | 200个客户自定义存储方法

????????????????

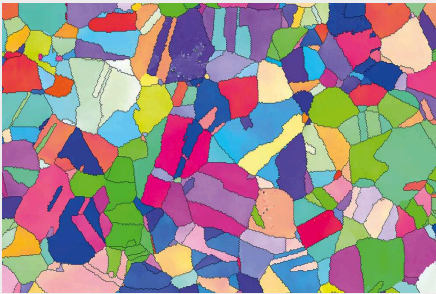

EBSD-奥氏体

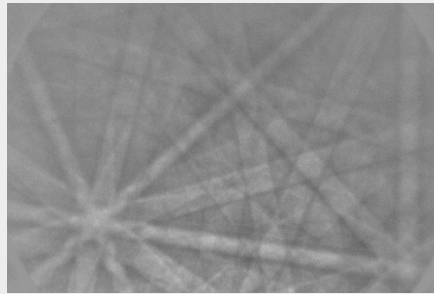

奥氏体组织

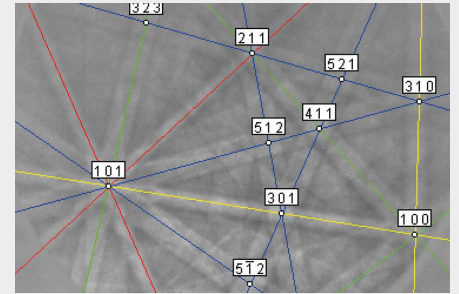

奥氏体的图案指数



振动抛光机 QPOL VIBRO

抛光-简单三步



设置安装震抛碗



?????????



加入悬浮液

简单聪明  
?????????

Qpol Vibro ??????????????????????15????????????????????????????????????Qpol Vibro ?????200????????????????????????????  
?USB??QATM ?  
??

Qpol Vibro ?????????????????????????????????????Qpol Vibro ???  
??



QATM表面防护功能

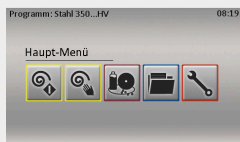

主菜单



自动模式

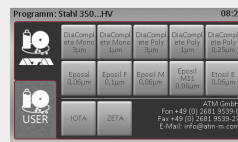

耗材菜单



制备方法菜单

?????????

右侧：使用表面防护功能

为了获得最佳结果  
丰富的配件选项



夹具

- | ?? 25-25.4 ???1?????? 300  
?????? 90 ?
- | ?? 25-25.4 ???1?????? 300  
?????? 90 ?
- | ?? 38-40 ???1 1/2?????? 550  
?????? 190 ?
- | ?? 50 ???2?????? 360 ??????  
190 ?



QPOL VIBRO 的调平盘

- | 调平镶嵌的样品
- | ??????25-50???1-2?????
- | ??????60???70?????????



特殊样品夹具

- | ?? 60 ????? 875 ????? 190  
?
- | ?? 70 ????? 605 ????? 190  
?



抛光池

- | ??????????308?????????????????
- | ??????????21?????
- | ??????????21?????
- | ??????????
- | ??????????
- | ??????????



抛光布

- | Iota, ??300?????????????????
- | Zeta, ??300?????????????????
- | 可以提供更多300mm直径的抛光布



各种抛光液

- | Eposal
- | Eposil F, Eposil M
- | Eposil Non Dry
- | Etosil E

### 完美的研磨和抛光 - QATM 耗材

研磨和抛光在使用正确的工具（知识、护理以及正确选择的耗材和设备）进行加工时，会更加可靠、安全和高效。



## 振动抛光机 QPOL VIBRO

### 技术参数

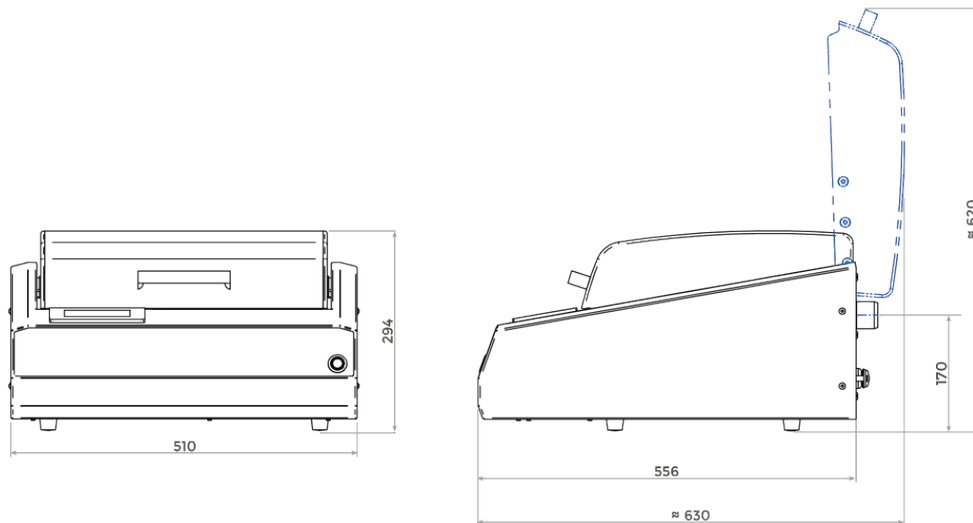

抛光槽内径	Ø 308 mm
Polishing cloth	300 mm, 305 mm (12")
振动频率	60 - 120 Hz, automatically regulated
Exhaust air connection	Ø 40 mm
环境温度	10 - 40 °C
IP Code	IP 22
运行功率	135 VA
连接功率	0.25 kVA
电源连接	220 - 240 V, 50/60 Hz (1 Ph/N/PE) 100 - 120 V, 50/60 Hz (1 Ph/N/PE)
界面	USB, Ethernet
B x H x T	510 x 300 x 590 mm
重量 (取决于设备)	approx. 45 kg

[www.qatm.cn/qpol-vibro](http://www.qatm.cn/qpol-vibro)

## ORDER DATA

### BASIC EQUIPMENT

#### MACHINE (ALL ITEMS REQUIRED)

M5651000  Qpol Vibro Base machine

#### POWER SUPPLY (1 ITEM REQUIRED)

A5651001 Qpol Vibro power supply 230V/50Hz (1Ph/N/PE)

A5651002 Qpol Vibro power supply 110V/60Hz (1Ph/N/PE)

### OPTIONS (CAN BE ORDERED SEPARATELY)

Z5651000  Polishing bowl

Z5651008 Sample holder 25 mm (1")

Z5651009 Sample holder 30-32 mm (1 1/4")

Z5651011 Sample holder 38-40 mm (1 1/2")

Z5651012 Sample holder Ø50 mm (2")

Z5651021  Sample holder glass slide 48x28 mm

Z5651013 Qpol Vibro Levelling plate

Z5651014 Qpol Vibro starter set

### POLISHING CONSUMABLES

### 地质和矿物学制样附件

#### BONDING JIG

- SPECIAL PRESSURE TRANSDUCERS FOR THE SIMULTANEOUS PROCESSING OF FOUR SAMPLES
- FOR TRADITIONAL MOUNTING MEDIA AND ADHESIVES

95017722  薄片压紧器

1 pc

载玻片			
95017713		载玻片 48x28 mm, 切边处理, 透明	50 pcs
95017714		载玻片 48x28 mm, 磨边处理, 透明	50 pcs
95017715		载玻片 48x28 mm, 切边处理, 麻面	50 pcs
95017716		载玻片 48x28 mm, 磨边处理, 麻面	50 pcs

盖玻片			
95017717		盖玻片 24x24 mm	100 pcs
95017718		盖玻片 24x40 mm	100 pcs

SLIDE BOXES			
95017719		可盛放25个玻片的玻片盒, 木制	1 pc
95017720		可盛放50个玻片的玻片盒, 木制	1 pc
95017721		可盛放100个玻片的玻片盒, 木制	1 pc

COVER MEDIUM			
95017723		用于粘接和覆盖样品的透明介质, 不含二甲苯	100 ml

玻片夹具			
95017724		适用于48x28 mm载玻片的手持式试样夹具, 采用铸铝材质, 符合人体工程学设计, 可在手动研磨机上使用, 尺寸为56x36x20 mm	1 pc

95017725		用于显微分析的显微镜玻片夹具76x32-48x28 mm, 适用于所有显微镜载玻片, 2.0 mm厚	1 pc
----------	---	--	------

**试样夹具**

Z5446091		岩相试样磨抛夹具, 单点力, 包含3个试样夹具插件, 适用玻片尺寸48x28 mm	1 pc
----------	---	---	------

Z5651021		Qpol Vibro用于薄片样品的夹具, 尺寸 48x28 mm	1 pc
----------	---	----------------------------------	------