



ВИБРАЦИОННАЯ ПОЛИРОВАЛЬНАЯ МАШИНА

QPOL VIBRO

VIBRATORY POLISHING NEWLY DISCOVERED

The vibratory polishing device Qpol Vibro is designed for the virtually deformation-free preparation of specimen surfaces. It is ideal for further characterizations, e.g. EBSD (electron backscatter diffraction), AFM analysis and nanoindentation or micro hardness testing.

With a diameter of $\varnothing = 308$ mm the large bowl provides sufficient space for polishing of completely filled sample holders, large specimens, as well as for simultaneously polishing up to 21 specimens. Held by strong magnets the polishing bowl can be easily removed by pressing a button and exchanged by simply putting it back into the device – the magnetic forces will do their job.

The clamping ring protects the edge of the polishing cloth to ensure a long service life. In addition, the ring delimits the polishing area and enables the sample holders to move evenly. The bowl is designed for the use of polishing cloths on magnetic systems. Consequently, the cloth is quickly and easily removed.



[Смотреть видео](#)

ПРЕИМУЩЕСТВА ОБОРУДОВАНИЯ

- | Rapidly exchangeable polishing bowl with magnetic system
- | Automatic frequency control from 60-120 Hz
- | Surface-Guard reduces crystallization of the suspension and corrosion of the specimen surface
- | Pre-installed preparation methods and consumable list
- | Low-noise operation and vibration-adsorbing construction
- | Transparent hood made of acrylic glass with soft-closing system
- | Preparation for external suction
- | Memory for 200 custom preparation methods

ANALYSIS AND CHARACTERIZATION OF THE PREPARED SURFACES

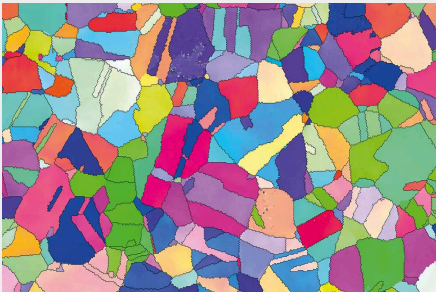

EBSD-Austenite

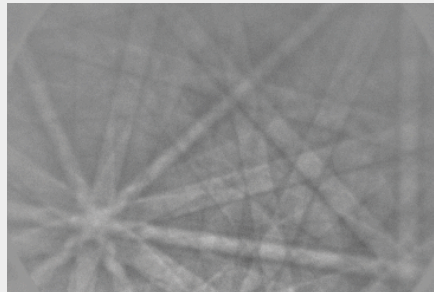

Pattern Austenite

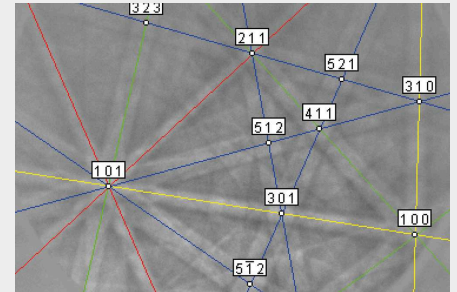

Pattern-index Austenite

ВИБРАЦИОННАЯ ПОЛИРОВАЛЬНАЯ МАШИНА QPOL VIBRO

SUPERIORITY IN DETAIL

1. Robust housing

- | Robust powder-coated aluminum housing
- | Easy to clean

2. Replaceable polishing tray

- | Magnetic attachment system enables quick replacement
- | QATM Surface-Guard reduces crystallization

3. 4.4" touch display

- | Intuitive and simple operation
- | Pre-installed preparation methods
- | Up to 200 user-defined preparation methods

4. Cushioned hood

- | Protects samples and polishing cloth from contamination
- | Allows easy visual inspection



ВИБРАЦИОННАЯ ПОЛИРОВАЛЬНАЯ МАШИНА QPOL VIBRO

ПРЕИМУЩЕСТВА

The Qpol Vibro offers silent operation based on its robust, high-quality design, innovative vibratory transmission angle, and vibrational motor with oscillation compensation. It may run for hours without any noticeable noise development. The oscillation compensation of the vibrational motor prevents the vibrations from being transmitted to the machine case or bench, thus ensuring silent operation of the Qpol Vibro. The exhaust connection plug may be connected to an external exhaust system to safely discharge moisture or gases, thus providing a safe working environment for the operator.

The transparent, soft-closing hinged hood shows the premium quality of QATM machines and devices. It protects the suspension and specimens from contamination for achieving best preparation results. The Qpol Vibro offers a wealth of features but is still compact and lightweight – with a weight of only 45 kg it is very suitable as a bench top device.

ВИБРАЦИОННАЯ ПОЛИРОВАЛЬНАЯ МАШИНА QPOL VIBRO

POLISHING - 3 EASY STEPS



| Setting up the polishing bowl



| Inserting the mounted sample



| Filling in the suspension

SIMPLY CLEVER

NEWLY DESIGNED USER INTERFACE

The innovative design of the Qpol Vibro software provides intuitive and user-friendly operation. 15 preparation methods for various materials are pre-installed, together with the appropriate consumables. The Qpol Vibro offers storage of up to 200 customized methods both on the device or on USB, allowing a transfer of methods from one device to another. These may be programmed without any restriction in duration or in vibration intensity. The device may be operated in manual or automatic mode. The selectively choosable alert function (timer) informs the operator that a program has ended. QATM invented a special operating mode to protect the prepared surface after preparation has finished: the Surface-Guard preserves the high quality of the prepared surface by preventing e.g. corrosion.

The Qpol Vibro is equipped with automatic frequency control which optimizes the oscillation frequency depending on the specific load of the bowl. The Qpol Vibro may be operated without supervision and almost without time-limit. This yields best polishing results and gives the user time for other tasks.



QATM Surface-Guard



Main Menu



Automatic mode



Menu consumables



Menu preparation methods

left: corrosion on specimen
right: with Surface-Guard

FOR OPTIMUM RESULTS

WIDE SELECTION OF ACCESSORIES



SAMPLE HOLDERS

- | Ø 25-25.4 mm (1"), 300 g, additional weight 90 g
- | Ø 25-25.4 mm (1"), 300 g, additional weight 90 g
- | Ø 38-40 mm (1 1/2"), 550 g, additional weight 190 g
- | Ø 50 mm (2"), 360 g, additional weight 190 g



LEVELLING DISCS QPOL VIBRO

- | For levelling of mounted specimens
- | Suitable for specimen with diameter 25-50 mm, 1-2"
- | Special levelling discs for specimens with diameter 60 mm and 70 mm



Special sample holders

- | Ø 60 mm, 875 g, additional weight 190 g
- | Ø 70 mm, 605 g, additional weight 190 g



POLISHING BOWL

- | Large bowl with $\varnothing = 308$ mm (inner diameter) for polishing non-mounted specimens, filled sample holders, and for simultaneous polishing of up to 21 specimens
- | Fast and easy changing of the bowl due to release button and magnetic system
- | Strong hold of bowl by magnetic forces
- | Especially designed for all polishing cloths with magnetic system
- | Lid protects polishing cloth from contamination



ПОЛИРОВАЛЬНЫЕ ТКАНИ

- | Iota, $\varnothing 300$ mm (long flocked, soft synthetic cloth)
- | Zeta, $\varnothing 300$ mm (short flocked, soft synthetic cloth)
- | Further polishing cloths $\varnothing 300$ mm available



SUSPENSIONS

- | Eposal
- | Eposil F, Eposil M
- | Eposil Non Dry
- | Etosil E

PERFECT GRINDING AND POLISHING – CONSUMABLES BY QATM

Grinding and polishing is more reliable, safe and efficient when processed with the right ingredients: knowledge, care and the right choice of consumables and instruments.



ВИБРАЦИОННАЯ ПОЛИРОВАЛЬНАЯ МАШИНА QPOL VIBRO

ХАРАКТЕРИСТИКИ

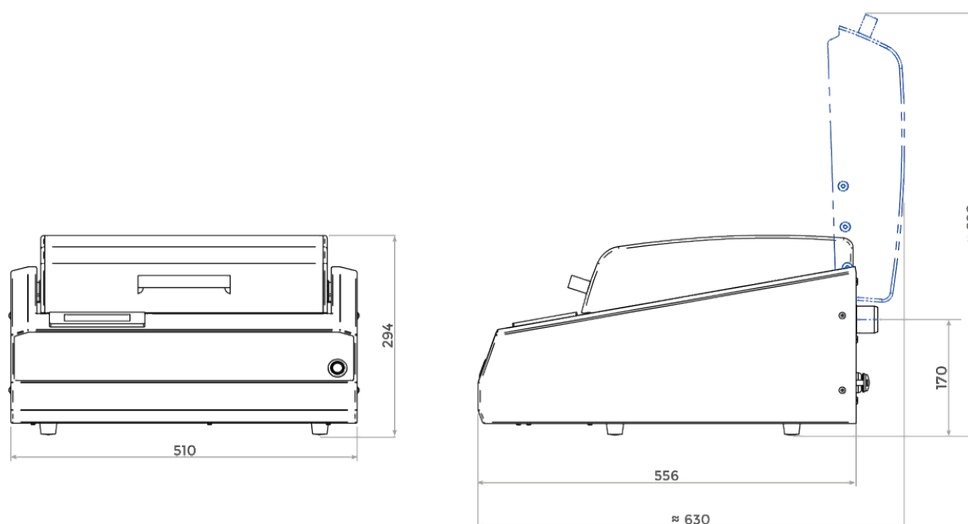

Inner diameter of the tub	Ø 308 mm
Polishing cloth	300 mm, 305 mm (12")
Частота вибрации	60 - 120 Hz, automatically regulated
Exhaust air connection	Ø 40 mm
Температура окружающей среды	10 - 40 °C
IP Code	IP 22
Мощность привода (шлифовальный круг)	135 BA (~95 Вт)
Connected load	0.25 kVA
Power connection	220 - 240 V, 50/60 Hz (1 Ph/N/PE) 100 - 120 V, 50/60 Hz (1 Ph/N/PE)
Внешние интерфейсы	USB, сеть
В x Н x Т	510 x 300 x 590 мм
Вес (в зависимости от комплектации)	approx. 45 kg

www.qatm.com/qpol-vibro

ИНФОРМАЦИЯ ДЛЯ ЗАКАЗА

БАЗОВОЕ ОБОРУДОВАНИЕ

МАШИНА (ОБЯЗАТЕЛЬНЫЕ ЭЛЕМЕНТЫ)

M5651000  Qpol Vibro Базовый блок

БЛОК ПИТАНИЯ (НЕОБХОДИМ - 1 ШТ.)

A5651001 Qpol Vibro подключение питания 230В/50Гц (1Ph/N/PE)

A5651002 Qpol Vibro подключение питания 110В/60Гц (1Ph/N/PE)

ОПЦИИ (МОГУТ ЗАКАЗЫВАТЬСЯ ОТДЕЛЬНО)

Z5651000  Чаша для машины

Z5651008 Sample holder 25 mm (1")

Z5651009 Sample holder 30-32 mm (1 1/4")

Z5651011 Sample holder 38-40 mm (1 1/2")

Z5651012 Sample holder Ø50 mm (2")

Z5651021  Sample holder glass slide 48x28 mm

Z5651013 Qpol Vibro Levelling plate

Z5651014 Qpol Vibro starter set

РАСХОДНЫЕ МАТЕРИАЛЫ ДЛЯ ПОЛИРОВАНИЯ

ACCESSORIES FOR GEOLOGY AND MINERALOGY





BONDING JIG

- SPECIAL PRESSURE TRANSDUCERS FOR THE SIMULTANEOUS PROCESSING OF FOUR SAMPLES
- FOR TRADITIONAL MOUNTING MEDIA AND ADHESIVES

95017722  Bonding jig

1 шт.



SLIDES

95017713		Slide 48x28 mm, cutted edges, clear	50 шт
95017714		Slide 48x28 mm, ground edges, clear	50 шт
95017715		Slide 48x28 mm, cutted edges, matted	50 шт
95017716		Slide 48x28 mm, ground edges, matted	50 шт

COVERSLIP

95017717		Coverslip 24x24 mm	100 шт.
95017718		Coverslip 24x40 mm	100 шт.

SLIDE BOXES

95017719		Slide box for 25 slides, wood	1 шт.
95017720		Slide box for 50 slides, wood	1 шт.
95017721		Slide box for 100 slides, wood	1 шт.

COVER MEDIUM



95017723		Cover medium, xylene free	100 мл
----------	---	---------------------------	--------

HOLDER FOR SLIDES

95017724		Hand sample holder for 48x28 mm slides cast aluminum, ergonomic working on manual grinding machines, 56x36x20 mm	1 шт.
----------	---	--	-------

95017725		Holder for microscope slides 76x32 to 48x28 mm for microscopy, for the use of all microscope slides, 2.0 mm thick	1 шт.
----------	---	---	-------

SAMPLE HOLDERS

Z5446091		Sample holder Geology, single pressure, incl. 3x sample holder insert 'Giessener format' 48x28 mm	1 шт.
Z5651021		Sample holder Qpol Vibro for thin sections, 'Giessener format' 48x28 mm	1 шт.