



РЕЖУЩИЙ РОБОТ

## QCUT 600 BOT



РЕЖУЩИЙ РОБОТ QCUT 600 BOT  
**SUPERIORITY IN DETAIL**

**1. Ergonomic control panel**

- | Large 12.1" industrial touchscreen with intuitive QATM software
- | Quick setup, control of all axes with two joysticks
- | The sliding control panel enables unobstructed working conditions

**2. Robust machine body**

- | Sturdy powder-coated steel construction
- | Integrable recirculating cooling unit
- | Automatic central lubrication of the axes

**3. Large round machine table**

- | Made of stainless steel with integrated longitudinal and cross T-slots

**5. Optimized swivel arm**

- | Highly efficient cooling system
- | Increased cutting capacity thanks to parallel guided cut-off wheel guard
- | Laser alignment aid for easy workpiece positioning

**6. Rotation axis, B-axis**

- | Rotation range 360°, with combined C-axis 200°
- | Positioning accuracy:  $\pm 0.1^\circ$

**7. Optional rotation axis, C-axis**

- | Rotation range: max. 360°
- | Removable modular rotation axis
- | Clamping capabilities can be expanded with a lathe chuck or other clamping devices



## СВОБОДНАЯ ДОСТУПНОСТЬ

### ДЛЯ БОЛЬШИХ ЗАГОТОВОК

Крупные компоненты можно размещать непосредственно с помощью вилочного погрузчика или крана через широкую раздвижную дверь.



## РЕЖУЩИЙ РОБОТ QCUT 600 BOT

### IN 5 DIMENSIONS, SECTIONING THE SMALL FROM THE LARGE

With the patented 5-axis technology, workpieces can be cut at any angle precisely, repeatably, quickly, and easily. All axes are finely adjustable and remain vibration-free during the cut-off process – precise work is easier than ever. The positioning capabilities/movement of the various axes in combination with the clamping systems enables precise cutting of the workpiece without time-consuming re-clamping of the workpiece. All necessary cut-offs can be performed sequentially and automatically – even with large workpieces.

#### 1. Y-AXIS (Chop cut)

- | Cutting range: 360 mm, automatic
- | Rapid traverse up to 80 mm/s.

## 2. Z-AXIS (Cross feed)

- | Travel: 550 mm, automatic
- | Cross feed for precise parallel cuts in series

## 3. B-AXIS (Rotation axis)

- | Rotation range: max. 360°, with combined C-axis 200°, automatic
- | Positioning accuracy:  $\pm 0.1^\circ$

## 4. X-AXIS (Travel cut)

- | Cutting range: 550 mm, automatic
- | Rapid traverse up to 80 mm/s.

## 5. C-AXIS (Rotation axis)

- | Rotation range: max. 360°, automatic
- | Removeable modular rotation axis

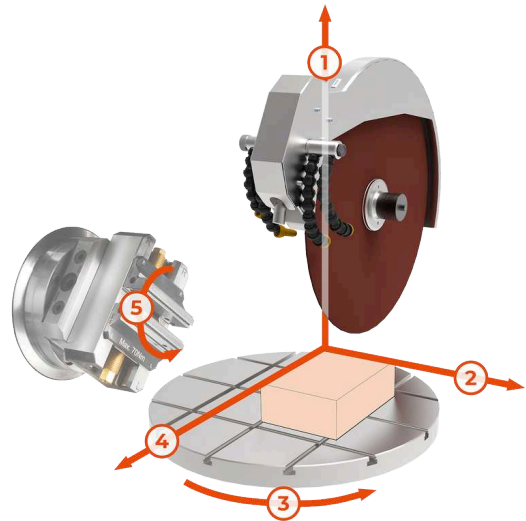

## РЕЖУЩИЙ РОБОТ QCUT 600 В0Т

### ОСОБЕННОСТИ



#### STAINLESS STEEL ROTARY TABLE

Spacious rotary table (∅ 600 mm) enables precise work even under heavy loads.

- | Rotation of the machine table (max. 360°) eliminates the need for time-consuming re-clamping of workpieces
- | Can be expanded with a modular adaptable rotation axis (C-axis)
- | Integrated T-slots for the Easy clamping system for quick mounting of clamping tools



#### AUTOMATIC CUT-OFF WHEEL MEASUREMENT

Dynamic cut-off wheel measurement leads to reproducible cutting results with consistent quality.

- | Automatic monitoring of the current cut-off wheel diameter
- | Adjustment of cutting parameters after each cut
- | Enables consistent cutting speed and cutting depth



#### ROBUST MACHINE WITH LARGE CUTTING CHAMBER

Robust, powder-coated steel machine body with large sliding door made of scratch-resistant laminated safety glass and large side door.

- | Machine body with integrable recirculating cooling unit and automatic central lubrication
- | Optimal access to the large cutting chamber with safety interlock that prevents door opening when the cut-off wheel is operating
- | Large side door for easy cut-off wheel replacement

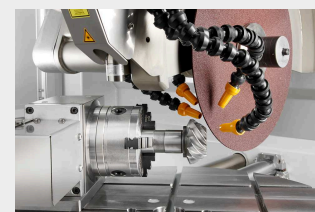

#### CUTTING OPTIMIZATION

To optimize the cutting quality, the machine automatically detects local material characteristics, such as hardened areas.

- | Cutting force-dependent feed control
- | Cut detection: When starting a new cut, the workpiece is automatically detected and approached at reduced speed
- | Parallel-guided cut-off wheel guard increases the cutting capacity of the cut-off wheel during chop cuts

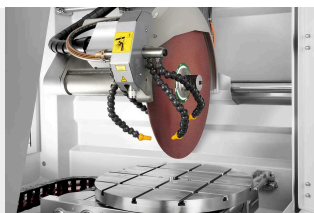

### POWERFUL CUT-OFF WHEEL DRIVE

Precise swivel arm guidance and cut-off wheel cooling.

- | Water-cooled main drive with 15 kW drive power
- | Optimal cooling thanks to flexibly adjustable cooling hoses
- | Parallel guided cut-off wheel guard for increased cutting capacity when making cross cuts



### INTUITIVE AND EASY OPERATION

Large 12.1" industrial touchscreen with intuitive QATM user software, joysticks, and emergency stop switch.

- | The teach function enables user-friendly programming of cutting positions by manually positioning the machine at each desired location
- | Simultaneous positioning and automatic cutting of different workpieces without re-clamping (Multi-Position Process MPP)

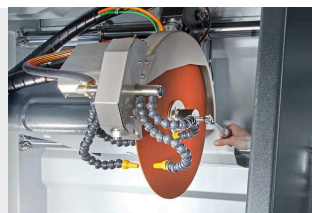

### CLEVER DESIGN

Easy cut-off wheel replacement and simple clamping allow you to focus on cutting.

- | Laser alignment for easy workpiece positioning
- | Power clamping nut: easy clamping and loosening of the cut-off wheel



### MAXIMUM EASE OF USE

The control panel is movable and can be freely positioned for ergonomic operation during setup and operation of the machine.

- | Programming in close proximity to the workpiece
- | During series operation, the control panel can be moved to the side

## РЕЖУЩИЙ РОБОТ QCUT 600 В0Т

### АКСЕССУАРЫ



RECIRCULATION



BELT FILTER SYSTEM



CENTRIFUGAL

## COOLING UNIT

Compact, integrable cooling system for standard applications.

- | Can be integrated into the housing and extended
- | Multi-chamber filtration
- | Inlet sieve with filter bag (see consumables)

Large cooling and filter system for continuous operation, e.g. in serial applications.

- | Tank size: 285 l
- | Filtering capacity: 100 l/min (referring emulsion)
- | Pump capacity: 100 l/min

## SEPARATOR

Work safety: Working environment with improved air quality.

- | Removes coolant mist
- | Purifies the air and increases visibility
- | Exhaust power 452 or 500 m<sup>3</sup>/h depending on voltage

## PERFECT CUTTING - CUT-OFF WHEELS FROM QATM

Резка более надежна, безопасна и эффективна, если для ее обработки используются правильные ингредиенты: знания, забота и правильный выбор расходных материалов и инструментов. The Qprep range includes specially developed cut-off wheels for a wide variety of materials and requirements.

- | Low thermal influence on the specimen during the cutting process
- | Wet abrasive cutting achieves very fine surface finishes after cutting
- | Optimal cutting shortens the further preparation process



## FAST, POWERFUL, FLEXIBLE - QTOOL CLAMPING DEVICES

Our innovative clamping devices are used to clamp workpieces securely and precisely to ensure exact cutting and grinding processes. There is a wide range of different clamping devices that have been developed for specific applications and workpiece sizes.

- | Suitable for regular and irregularly shaped samples
- | Fast, repeat-accurate clamping of regularly shaped samples
- | Large range of different clamping tools and systems available

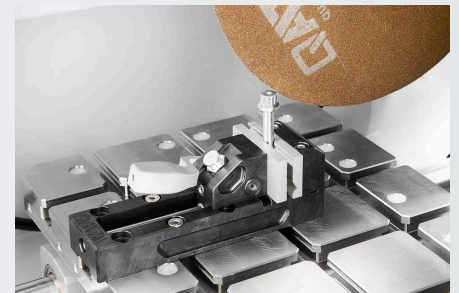

РЕЖУЩИЙ РОБОТ QCUT 600 BOT

## ХАРАКТЕРИСТИКИ



Конфигурация станка с 4 (X/Y/Z/B) или 5 осями (X/Y/Z/B/C)

[www.qatm.com/qcut-600-bot](http://www.qatm.com/qcut-600-bot)

## ИНФОРМАЦИЯ ДЛЯ ЗАКАЗА

### БАЗОВОЕ ОБОРУДОВАНИЕ

#### МАШИНА (ОБЯЗАТЕЛЬНЫЕ ЭЛЕМЕНТЫ)

M1831001  Qcut 600 BOT (4-axis) base machine 400V 50Hz (3Ph/N/PE)

M1831003  Qcut 600 BOT (5-axis) base machine 400V 50Hz (3Ph/N/PE)

M1831002  Qcut 600 BOT (4-axis) base machine 480V 60Hz (3Ph/PE)

M1831004  Qcut 600 BOT (5-axis) base machine 480V 60Hz (3Ph/PE)

#### ЗАЩИТНЫЙ КОЖУХ ДЛЯ ДИСКА (НЕОБХОДИМ - 1 ШТ.)

A1831001 Wheel guard 500mm

A1831010 Wheel guard 600mm

#### СИСТЕМА РЕЦИРКУЛЯЦИИ (НЕОБХОДИМА - 1 ШТ.)

A1831005  Recirculation cooling system 400V 50Hz (3Ph/PE)

A1831006 Rrecirculation cooling system 480V 60Hz (3Ph/PE)

A6501000  Belt filter 285 400V 50Hz (3Ph/PE)

A6501002  Belt filter 285 480V 60Hz (3Ph/PE)

Z6501007 Комплект подключения ленточной системы фильтрации 285

### ОПЦИИ (ЗАКАЗЫВАЮТСЯ С МАШИНОЙ)

A1831004  Laser alignment aid

A1831007 Centrifugal separator 400V 50Hz (3Ph/PE)

A1831009 Centrifugal separator 480V 60Hz (3Ph/PE)

## PRECISION CLAMPING DEVICES, CLAMPING\_DEVICES, PRECISION\_CLAMPING\_DEVICES

Z1870063	Reduction ring Ø 30 mm, Clamping_devices, Precision_clamping_devices
Z1870069	Manual chuck Ø 44 mm, Clamping_devices, Precision_clamping_devices

## QUICK CLAMPING TOOLS, CLAMPING\_DEVICES

### QTOOL 80, CLAMPING\_DEVICES, QTOOL\_SERIES

Z2231203	Qtool 80 - 100mm, Clamping_devices, Qtool_series
Z2231204	Qtool 80 - 150mm, Clamping_devices, Qtool_series
02231243	Clamping jaw 40 mm, Clamping_devices, Qtool_series
Z2231215	Clamping jaws 70 mm, Clamping_devices, Qtool_series
02231245	Clamping jaw 40 mm bevelled, Clamping_devices, Qtool_series
02231246	Clamping jaw 40 mm cross prism, Clamping_devices, Qtool_series
Z2231216	Clamping jaws 70 mm slotted, Clamping_devices, Qtool_series
Z2231217	Clamping jaws 70 mm slotted prism, Clamping_devices, Qtool_series

### QTOOL 80 VARIO, CLAMPING\_DEVICES, QTOOL\_SERIES

Z2231200	Qtool 80 Vario - 100 mm, Clamping_devices, Qtool_series
Z2231201	Qtool 80 Vario - 150 mm, Clamping_devices, Qtool_series
Z2231202	Qtool 80 Vario - 250 mm, Clamping_devices, Qtool_series
Z2231210	Workpiece stop, Clamping_devices, Qtool_series
02231200	Clamping jaw, 40 mm - for Qtool 80 Vario, Clamping_devices, Qtool_series
Z2231211	Clamping jaws, 70 mm, Clamping_devices, Qtool_series
02231213	Prism jaw, 40 mm, Clamping_devices, Qtool_series
02231229	Bevelled jaw, 40 mm, Clamping_devices, Qtool_series
02231230	Cross prism jaw, 40 mm, Clamping_devices, Qtool_series
Z2231212	Round bar jaws, 70 mm slotted, Clamping_devices, Qtool_series
Z2231213	Prism jaws, 70 mm slotted, Clamping_devices, Qtool_series
Z2231214	Clamping jaws, 70 mm slotted, Clamping_devices, Qtool_series

## POWER CLAMPING SYSTEMS, CLAMPING\_DEVICES, POWER\_CLAMPING\_SYSTEMS

### POWER CLAMPING SYSTEM 100-540, CLAMPING\_DEVICES, POWER\_CLAMPING\_SYSTEMS

Z2234016	Power clamping system 100-540, Clamping_devices, Power_clamping_systems
Z2234018	Prism clamping jaw, Clamping_devices, Power_clamping_systems
Z2234017	Clamping jaw flat, Clamping_devices, Power_clamping_systems
Z2234019	Angular drive, Clamping_devices, Power_clamping_systems

### POWER CLAMPING SYSTEM LC 90, CLAMPING\_DEVICES, POWER\_CLAMPING\_SYSTEMS

Z2234001	Power clamping system LC 90, Clamping_devices, Power_clamping_systems
Z2234003	Carrier jaws LC 90, Clamping_devices, Power_clamping_systems
Z2234004	V-groove jaw 100, Clamping_devices, Power_clamping_systems
Z2234005	Clamping jaw flat, Clamping_devices, Power_clamping_systems
Z2234009	Quick-change adapter, Clamping_devices, Power_clamping_systems
Z2234008	Step jaw 100, Clamping_devices, Power_clamping_systems
Z2234002	Clamping system X-Clamp 100, Clamping_devices, Power_clamping_systems
Z2234006	Socket 90°, Clamping_devices, Power_clamping_systems

## БЫСТРО-ЗАЖИМНЫЕ СИСТЕМЫ, CLAMPING\_DEVICES, EASY\_CLAMPING\_PLATES

## CLAMPING ACCESSORIES FOR ROTATING, SWIVELING AND SPECIAL APPLICATIONS, CLAMPING\_DEVICES, CLAMPING\_ACCESSORIES\_SPECIALS

Z1304636	Expansion clamping device, Clamping_devices, Clamping_accessories_specials
Z1340000	 Поперечные тиски 80/100, Clamping_devices, Clamping_accessories_specials
Z1340001	Поперечные тиски 80/150, Clamping_devices, Clamping_accessories_specials



### УГЛОВЫЕ И ПОВОРОТНЫЕ ТИСКИ, CLAMPING\_DEVICES, CLAMPING\_ACCESSORIES\_SPECIALS

Z1304001	Угловые тиски 60, Clamping_devices, Clamping_accessories_specials
01304008	Щека V-образная для угловых тисков 60, Clamping_devices, Clamping_accessories_specials
Z1302000	Угловые тиски 80, Clamping_devices, Clamping_accessories_specials
01302016	Щека V-образная для угловых тисков 80, Clamping_devices, Clamping_accessories_specials

## ROTATIG DEVICES, CLAMPING\_DEVICES, ROTATION\_DEVICES

Z1870059	Rotation device type RD1, Clamping_devices, Rotation_devices
Z1891001	Rotation device type RD2.1, Clamping_devices, Rotation_devices

## УНИВЕРСАЛЬНЫЕ ТИСКИ И АКСЕССУАРЫ, CLAMPING\_DEVICES, UNIVERSAL\_VICES\_AND\_ACCESSORIES

Z1350025	Clamping rail, Clamping_devices, Universal_vices_and_accessories
01350022	Prism 120°, Clamping_devices, Universal_vices_and_accessories
01350023	Prism slim, Clamping_devices, Universal_vices_and_accessories
01350024	Prism 90°, Clamping_devices, Universal_vices_and_accessories
01350025	Prism 90° high, Clamping_devices, Universal_vices_and_accessories
Z1350002	 Универсальный зажим Mono 61, Clamping_devices, Universal_vices_and_accessories
Z1350004	 Комплект Mono 61 в чемоданчике, Clamping_devices, Universal_vices_and_accessories
Z1350011	 Зажим универсальный Mono 132, Clamping_devices, Universal_vices_and_accessories
Z1350005	Универсальные тиски Duo, Clamping_devices, Universal_vices_and_accessories
Z1350006	Универсальный цепной зажим, Clamping_devices, Universal_vices_and_accessories
92005796	Пятка V-образная продольная, для Mono/Piccolo, Clamping_devices, Universal_vices_and_accessories
92005797	Пятка V-образная поперечная, для Mono/Piccolo, Clamping_devices, Universal_vices_and_accessories
92005799	Пятка продольная, для Mono/Piccolo, Clamping_devices, Universal_vices_and_accessories

92005800	Пятка поперечная, для Mono/Piccolo, Clamping_devices, Universal_vices_and_accessories
92005798	Пятка стандартная, для Mono/Piccolo, Clamping_devices, Universal_vices_and_accessories
Z1350007	Адаптер высоты Piccolo, 60мм, Clamping_devices, Universal_vices_and_accessories
Z1350003	Адаптер высоты Mono, 74мм, Clamping_devices, Universal_vices_and_accessories
95003172	Удлинитель рычага для Piccolo 54 и Mono 61, Clamping_devices, Universal_vices_and_accessories
Z1304591	Фиксирующий болт M6 x 25 мм для универсальных зажимов, Clamping_devices, Universal_vices_and_accessories
95003169	Fixing screw Piccolo M8 x 25, Clamping_devices, Universal_vices_and_accessories
95003170	Fixing screw Piccolo M10 x 25, Clamping_devices, Universal_vices_and_accessories
95003168	Fixing screw Mono M10 x 32, Clamping_devices, Universal_vices_and_accessories
91001157	T-гайка, M6 x 8, нержавеющая сталь, Clamping_devices, Universal_vices_and_accessories
91001161	T-гайка, M8 x 10, нержавеющая сталь, Clamping_devices, Universal_vices_and_accessories
91001159	T-гайка, M8 x 12, нержавеющая сталь, Clamping_devices, Universal_vices_and_accessories
91001158	T-гайка, M10 x 12, нержавеющая сталь, Clamping_devices, Universal_vices_and_accessories