



DOORSLIJPMACHINE

QCUT 250 M

De Qcut 250 M is een bijzonder gebruiksvriendelijk handmatige nat doorslijpmachine. Bij het openen van de machine vouwt de kap naar binnen, zodat de hele snijkamer gemakkelijk toegankelijk is. Het afgeronde venster zorgt ervoor dat de gebruiker een optimaal gezichtsveld heeft tijdens het snijproces.

De koelsysteem is rechtstreeks geïntegreerd in het wielbeveiligingsdeksel. De grote, roestvrije tafel is voorzien van vervangbare slijtplaten. Transversale groeven zorgen voor een optimale opstelling van de klemmen (b.v. clamping vice 80).

PRODUCTVOORDELEN

- | Handmatige verticale beweging
- | Ruime snijkamer
- | Opening aan de linker- en rechterkant voor eventuele lange delen
- | Grote tafel met uitwisselbare slijtplaten
- | Kap over volledige breedte voor optimale toegankelijkheid
- | Eenvoudige bediening
- | Alle onze klemsystemen zijn universeel te gebruiken met de Brillant
- | Huidige veiligheidsnorm met deurvergrendelingsstelsel
- | Gepoedercoate, solide aluminium behuizing

KENMERKEN

FINE DYNAMIC CUT-OFF

The manual cutting movement of the Y-axis is executed precisely and jerk-free via lever. Length and angle of the lever are adjustable. Further, the cutting depth can easily be adjusted by using a limiter.

ILLUMINATION

Through the large rounded window, the cutting chamber is comfortably visible. For direct lighting, the Qcut 250 M can be equipped with a flexible LED light.

SAFETY

The integrated standstill monitoring allows opening only when the cutting wheel is not rotating.

PERFECT CUTTING - CUT-OFF WHEELS FROM QATM

Cutting is more reliable, safe and efficient when processed with the right ingredients: knowledge, care and the right choice of consumables and instruments.



SNEL, KRACHTIG, FLEXIBEL - KLEMSYSTEMEN VAN QTOOLS

Onze innovatieve klemsystemen worden gebruikt om werkstukken veilig en nauwkeurig vast te klemmen om exact door te slijpen of te polijsten. Er is een uitgebreid pakket aan verschillende klemsystemen beschikbaar, die ontworpen werden voor specifieke toepassingen en werkstuk-afmetingen.

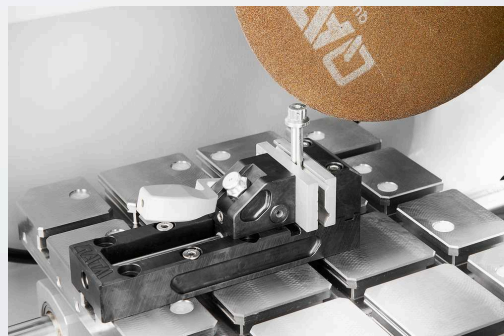

DOORSLIJPMACHINE QCUT 250 M
TECHNISCHE GEGEVENS

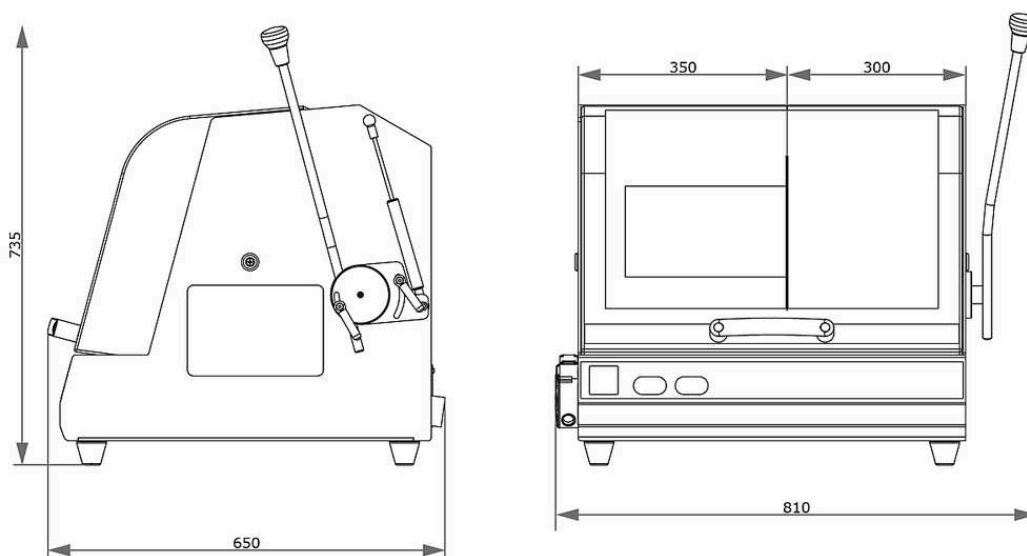

Doorslijpschijf	up to \varnothing 250 mm/10"
Max. cutting capacity	\varnothing 55 mm / \varnothing 90 mm (up to 25 mm length)
Afmeting flens voor slijpschijf	\varnothing 32 mm
Y-as (verticale beweging)	145 mm
Table WxD	350 x 288 mm stainless
T-slot	12 mm
Aansluitvermogen	4.5 kVA
Vermogen aanrijving (hoofdaandrijving)	3 kW S6 40%
B x H x D	810 x 735 x 650 mm
Gewicht	~ 75 kg

www.qatm.com/qcut-250-m

BESTELGEGEVENS

BASIS UITRUSTING

MACHINE (ALLE POSITIES NOODZAKELIJK)

M1880000  Qcut 250 M (Brillant 200) Base machine

STROOMVOORZIENING (1 ITEM NOODZAKELIJK)

A1880000 Qcut 250 M power supply 400V/50Hz (3Ph/N/PE)

A1880001 Qcut 250 M power supply 480V/60Hz (3/PE)

A1880002 Qcut 250 M power supply 220V/60Hz (3/PE)

RECIRCULATION SYSTEM (1 ITEM REQUIRED)

A5800484  Recirculation Cooling System 45L 400V/50Hz (3Ph/PE) mobile, with insertion mechanism

A5800485  Recirculation Cooling System 45L 480V/60Hz (3Ph/PE) mobile, with insertion mechanism

A5800486  Recirculation Cooling System 45L 220V/60Hz (3Ph/PE) mobile, with insertion mechanism

A5800487  Recirculation Cooling System 45L 400V/50Hz (3Ph/PE) mobile, without folding wheels

A5800488  Recirculation Cooling System 45L 480V/60Hz (3Ph/PE) mobile, without folding wheels

A5800489  Recirculation Cooling System 45L 220V/60Hz (3Ph/PE) mobile, without folding wheels

OPTIONS (TO BE ORDERED WITH MACHINE)

Z1820009  Centrifugal separator (machine mounted) 400V/50Hz/3 Ph

Z1820012  Centrifugal separator (machine mounted) 480V/60Hz/3 Ph

Z1820011



Centrifugal separator (machine mounted) 220V/60Hz/3 Ph

PRECISION CLAMPING DEVICES, CLAMPING_DEVICES, PRECISION_CLAMPING_DEVICES

Z1870035	Sample holder L standard Ø 40 mm open, Clamping_devices, Precision_clamping_devices
Z1870037	Sample holder L standard Ø 40 mm closed, Clamping_devices, Precision_clamping_devices
Z1870039	Sample holder L Flex Ø 40 mm, Clamping_devices, Precision_clamping_devices
Z1870043	Sample holder L parallel clamping vice open, Clamping_devices, Precision_clamping_devices
Z1870041	Sample holder L parallel clamping vice closed, Clamping_devices, Precision_clamping_devices
Z1870045	Drop shape sample holder L Ø 40 mm, Clamping_devices, Precision_clamping_devices
Z1870047	Universal clamping vice L, Clamping_devices, Precision_clamping_devices
Z1870049	Matrix clamping vice L, Clamping_devices, Precision_clamping_devices
Z1870054	Mini vice L, Clamping_devices, Precision_clamping_devices
Z1870056	Double parallel vice L, Clamping_devices, Precision_clamping_devices
Z1870058	Adaptor with ball joint L, Clamping_devices, Precision_clamping_devices
Z1870063	Reduction ring Ø 30 mm, Clamping_devices, Precision_clamping_devices
Z1870071	Reduction ring Ø 40 mm, Clamping_devices, Precision_clamping_devices
Z1870067	Reduction ring 1", Clamping_devices, Precision_clamping_devices
Z1870066	Reduction ring 1 1/4", Clamping_devices, Precision_clamping_devices
Z1870065	Reduction ring 1 1/2", Clamping_devices, Precision_clamping_devices
Z1870069	Manual chuck Ø 44 mm, Clamping_devices, Precision_clamping_devices
Z1870070	Manual chuck Ø 56 mm, Clamping_devices, Precision_clamping_devices

VACUUM CLAMPING VICES, CLAMPING_DEVICES, PRECISION_CLAMPING_DEVICES

Z1870028	Vacuum sample holder, Clamping_devices, Precision_clamping_devices
01870288	Vacuum holder (sacrificial plate), Clamping_devices, Precision_clamping_devices

Z1304600 Vacuum pump 230V/50Hz for vacuum sample holder, Clamping_devices, Precision_clamping_devices

Z1304634 Vacuum pump 110V/60Hz for vacuum sample holder, Clamping_devices, Precision_clamping_devices

QUICK CLAMPING TOOLS, CLAMPING_DEVICES

QTOOL 60, CLAMPING_DEVICES, QTOOL_SERIES

Z2235200 Qtool 60, Clamping_devices, Qtool_series

02235202 Clamping jaw 32 mm - for Qtool 60, Clamping_devices, Qtool_series

Z2235201 Clamping jaws 60 mm - for Qtool 60, Clamping_devices, Qtool_series

02235212 Clamping jaw 32 mm bevelled - for Qtool 60, Clamping_devices, Qtool_series

02235213 Clamping jaw 32 mm cross prism - for Qtool 60, Clamping_devices, Qtool_series

Z2235202 Clamping jaws 60 mm slotted - for Qtool 60, Clamping_devices, Qtool_series

Z2235203 Clamping jaws 60 mm slotted prism - for Qtool 60, Clamping_devices, Qtool_series

QTOOL 80, CLAMPING_DEVICES, QTOOL_SERIES

Z2231203 Qtool 80 - 100mm, Clamping_devices, Qtool_series

02231243 Clamping jaw 40 mm, Clamping_devices, Qtool_series

Z2231215 Clamping jaws 70 mm, Clamping_devices, Qtool_series

02231245 Clamping jaw 40 mm bevelled, Clamping_devices, Qtool_series

02231246 Clamping jaw 40 mm cross prism, Clamping_devices, Qtool_series

Z2231216 Clamping jaws 70 mm slotted, Clamping_devices, Qtool_series

Z2231217 Clamping jaws 70 mm slotted prism, Clamping_devices, Qtool_series

QTOOL 80 VARIO, CLAMPING_DEVICES, QTOOL_SERIES

Z2231200 Qtool 80 Vario - 100 mm, Clamping_devices, Qtool_series

Z2231210 Workpiece stop, Clamping_devices, Qtool_series

02231200 Clamping jaw, 40 mm - for Qtool 80 Vario, Clamping_devices, Qtool_series

Z2231211 Clamping jaws, 70 mm, Clamping_devices, Qtool_series

02231213 Prism jaw, 40 mm, Clamping_devices, Qtool_series

02231229 Bevelled jaw, 40 mm, Clamping_devices, Qtool_series

02231230	Cross prism jaw, 40 mm, Clamping_devices, Qtool_series
Z2231212	Round bar jaws, 70 mm slotted, Clamping_devices, Qtool_series
Z2231213	Prism jaws, 70 mm slotted, Clamping_devices, Qtool_series
Z2231214	Clamping jaws, 70 mm slotted, Clamping_devices, Qtool_series

EASY-CLAMPING PLATES, CLAMPING_DEVICES, EASY_CLAMPING_PLATES

ACCESSORIES FOR EASY-CLAMPING PLATES

Z2236032	Easy adaption horizontal, Clamping_devices, Easy_clamping_plates
Z2236033	Easy adaption vertical, Clamping_devices, Easy_clamping_plates
Z2236034	Easy adaption Qtool 40 - 60, Clamping_devices, Easy_clamping_plates
Z2236038	Multitower rotating plate, Clamping_devices, Easy_clamping_plates
Z2236039	Multitower, Clamping_devices, Easy_clamping_plates
Z2236040	Swivel unit Qtool 40 - 60, Clamping_devices, Easy_clamping_plates
Z2236036	Easy-multifunctional plate, Clamping_devices, Easy_clamping_plates







CLAMPING ACCESSORIES FOR ROTATING, SWIVELING AND SPECIAL APPLICATIONS, CLAMPING_DEVICES, CLAMPING_ACCESSORIES_SPECIALS

Z2236041	Swivel unit Qtool 60 - 80, Clamping_devices, Clamping_accessories_specials
Z1304643	Screw clammer with Easy-clamping plate M, Clamping_devices, Clamping_accessories_specials
Z1304636	Expansion clamping device, Clamping_devices, Clamping_accessories_specials
Z2236009	Vertical clamp single, Clamping_devices, Clamping_accessories_specials
Z2236010	Vertical clamp double, Clamping_devices, Clamping_accessories_specials
Z2234010	Clamping system X-Clamp 3858, Clamping_devices, Clamping_accessories_specials

CROSS VICES, CLAMPING_DEVICES, CLAMPING_ACCESSORIES_SPECIALS

Z1340010	 Cross vice 50 - 100, Clamping_devices, Clamping_accessories_specials
----------	--

UNIVERSAL VICES AND ACCESSORIES, CLAMPING_DEVICES, UNIVERSAL_VICES_AND_ACCESSORIES

01350022		Prism 120°, Clamping_devices, Universal_vices_and_accessories
01350023		Prism slim, Clamping_devices, Universal_vices_and_accessories
01350024		Prism 90°, Clamping_devices, Universal_vices_and_accessories
01350025		Prism 90° high, Clamping_devices, Universal_vices_and_accessories
Z1350008		Universal vice Piccolo 54, Clamping_devices, Universal_vices_and_accessories
Z1350010		Suitcase set universal vice Piccolo 54, Clamping_devices, Universal_vices_and_accessories
Z1350012		Universal vice Piccolo 100, Clamping_devices, Universal_vices_and_accessories
Z1350002		Universal vice Mono 61, Clamping_devices, Universal_vices_and_accessories
Z1350004		Suitcase set universal vice Mono 61, Clamping_devices, Universal_vices_and_accessories
Z1350011		Universal vice Mono 132, Clamping_devices, Universal_vices_and_accessories
Z1350005		Universal vice Duo, Clamping_devices, Universal_vices_and_accessories
Z1350006		Chain vice set, Clamping_devices, Universal_vices_and_accessories
92005796		Longitudinal v-shoe, Clamping_devices, Universal_vices_and_accessories
92005797		Traverse v-shoe, Clamping_devices, Universal_vices_and_accessories
92005799		Longitudinal bridge, Clamping_devices, Universal_vices_and_accessories
92005800		Traverse bridge, Clamping_devices, Universal_vices_and_accessories
92005798		Standard clamping shoe, Clamping_devices, Universal_vices_and_accessories
Z1350007		Height adapter 60mm Piccolo, Clamping_devices, Universal_vices_and_accessories
Z1350003		Height adapter 74mm Mono, Clamping_devices, Universal_vices_and_accessories
95003172		Clamping arm extension Piccolo 54 and Mono 61, Clamping_devices, Universal_vices_and_accessories
Z1304591		Fixing screw M6 x 25, Clamping_devices, Universal_vices_and_accessories
95003169		Fixing screw Piccolo M8 x 25, Clamping_devices, Universal_vices_and_accessories

95003170	Fixing screw Piccolo M10 x 25, Clamping_devices, Universal_vices_and_accessories
95003168	Fixing screw Mono M10 x 32, Clamping_devices, Universal_vices_and_accessories
91001157	T-slot nut - stainless M6 x 8, Clamping_devices, Universal_vices_and_accessories
91001161	T-slot nut - stainless M8 x 10, Clamping_devices, Universal_vices_and_accessories
91001159	T-slot nut - stainless M8 x 12, Clamping_devices, Universal_vices_and_accessories
91001158	T-slot nut - stainless M10 x 12, Clamping_devices, Universal_vices_and_accessories