



PRECISIE DOORSLIJPMACHINE

## QCUT 200 A



PRECISIE DOORSLIJPMACHINE QCUT 200 A

**KENMERKEN**

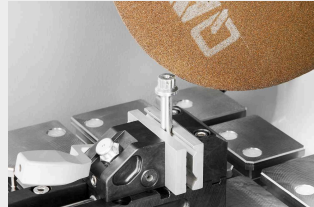

**HIGHEST DEMANDS OF SAFETY**

- | Due to the enabling switch, the machine can only be positioned via the two-hand control when the door is open.
- | The risk of crushing for the machine operator is virtually eliminated

**INTELLIGENT COMPONENT DETECTION**

- | Proven automatic component detection and a new type of exit detection (auto-stop function)
- | Start and end points of the cutting process are automatically detected and process times are shortened

**HIGHEST PRECISION THANKS TO ROBUST DESIGN**

- | Durable and low vibration thanks to stable construction
- | Cutting or grinding (using a cup wheel) of delicate samples with maximum precision
- | Excellent access to the cutting chamber thanks to large sliding door
- | Quick and secure attachment of versatile clamping devices on the large machine table

**INTUITIVE AND SIMPLE OPERATION**

- | Large 7" industrial touchscreen with ergonomic user guidance
- | Easy operation of the user-friendly software
- | Comfortable movement of automatic axes using the Joystick



### FLOW MONITORING

- | Optional flow monitoring ensures constant cooling of sensitive samples even during long cutting processes
- | The cutting process is automatically interrupted as soon as a critical threshold value is reached

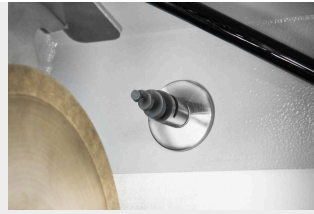

### AUTOMATIC CLEANING FUNCTION

- | Fully automatic machine cleaning thanks to spiral nozzles in the cutting chamber
- | Cleaning can be switched on individually and starts automatically after each cut if required
- | Clear view during the cutting process: cleaning can be activated during the running process



### EXTENSIVE CUTTING PROGRAMS

- | Depending on the geometry of the component, the travel or chop cut is used to minimize the contact area to the cut-off wheel
- | Cut the workpiece layer by layer and optimize the angle of action using the step cut functions – particularly suitable for solid material

DIT INSTRUMENT IS IDEAAL  
VOOR GEOLOGISCHE EN  
MINERALOGISCHE  
TOEPASSINGEN

PRECISIE DOORSLIJPMACHINE QCUT 200 A

## SNIJDEN ZONDER BEPERKINGEN

### 1. Cutting chamber flushing

- | Automatic cleaning of the cutting chamber

### 2. Large machine table

- | Axes can be positioned backlash-free
- | Easy grooves for simple mounting of QATM clamping devices
- | T-slots 8 mm for individual clamping devices
- | Max. W x H: 300 mm x 210 mm

### 3. Ergonomic control panel

- | Large 7" TFT touch display
- | Joystick for manual operation

### 4. Laser alignment

- | For exact component part positioning before cutting
- | Included as standard

### 5. Accessories

- | Clamping possibility individually expandable with turning device or further clamping devices

### 6. Cut-off wheel lock

- | Simplified cut-off wheel change via locking function
- | With integrated lubrication option

### 7. Dressing device

- | For sharpening diamond cutting and grinding wheels
- | Can be operated manually from the outside

### 8. Centrifugal separator

- | Effective removal of coolant mist from the sectioning process



OPTIMAL ACCESSORIES FOR QCUT 150 A AND 200 A

## RECIRCULATION COOLING SYSTEMS

Optimal cooling is essential during sectioning. Excessive heat generation during the sectioning process damages the specimen and increases the wear of the cut-off wheel. The cooling and corrosion protection agent dissipates the heat and simultaneously removes the chips from the cut-off chamber.



### 15L RECIRCULATION COOLING SYSTEM

- | Portable system with filter cartridge and lid
- | Small footprint required
- | Easy to integrate into existing laboratory furniture
- | Two-chamber system for filtration



### 45L RECIRCULATION COOLING SYSTEM (MOBILE)

- | Mobile unit with inlet strainer, filter bag and overflow
- | Can be placed under a lab bench or floor-to-ceiling cabinet
- | Expandable with optional pump module for cut-off chamber flushing
- | Two-chamber system for filtration with removable separating slide



### 45L RECIRCULATION COOLING SYSTEM (SYSTEM LAB)

- | Mobile unit with retractable mechanism
- | Can be conveniently integrated into QATM system laboratory cabinets and cabinets with undershelves
- | Expandable with optional pump module for cut-off chamber flushing
- | Inlet strainer, filter bag and overflow
- | Two-chamber system for filtration with removable separating slide

TOEBEHOREN

## CLAMPING TOOLS

A wide range of clamping tools is available for the Qcut 200 A. Using the Easy clamping system, they can be simple and securely fastened to the table with just one screw. This makes the tedious fixing of the clamping tools in the T-slots of the table unnecessary. The Easy clamping system is an innovative addition with a great impact on everyday work.



Easy-clamping base S  
with rotary function +  
easy adaption (vertical)

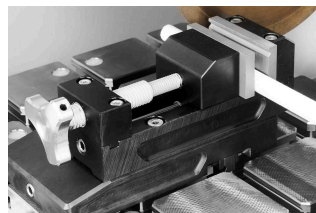

Easy-clamping base S  
with Qtool 40 S

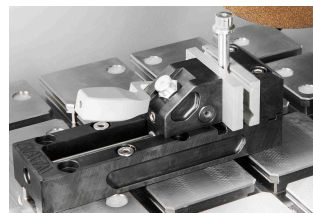

Qtool 40



[Klik om video te  
bekijken](#)

Clamping and cutting  
of challenging samples  
(Video)

## PERFECT CUTTING - CUT-OFF WHEELS FROM QATM

Cutting is more reliable, safe and efficient when processed with the right ingredients: knowledge, care and the right choice of consumables and instruments. The Qprep range includes specially developed cut-off wheels for a wide variety of materials and requirements.

- | Low thermal influence on the specimen during the cutting process
- | Wet abrasive cutting achieves very fine surface finishes after cutting
- | Optimal cutting shortens the further preparation process



## PRECISION CLAMPING DEVICES

The Precision Series from QATM offers versatile clamping for both regular and irregularly shaped samples, designed for the most demanding and precise materialographic applications.

- | Handles Irregular and Complex Geometries
- | Varied and Versatile Product Range
- | Works with Rotating Device Integration (Qcut 150 A)
- | Horizontal and Vertical Adaptation Available



PRECISIE DOORSLIJPMACHINE QCUT 200 A

**TECHNISCHE GEGEVENS**

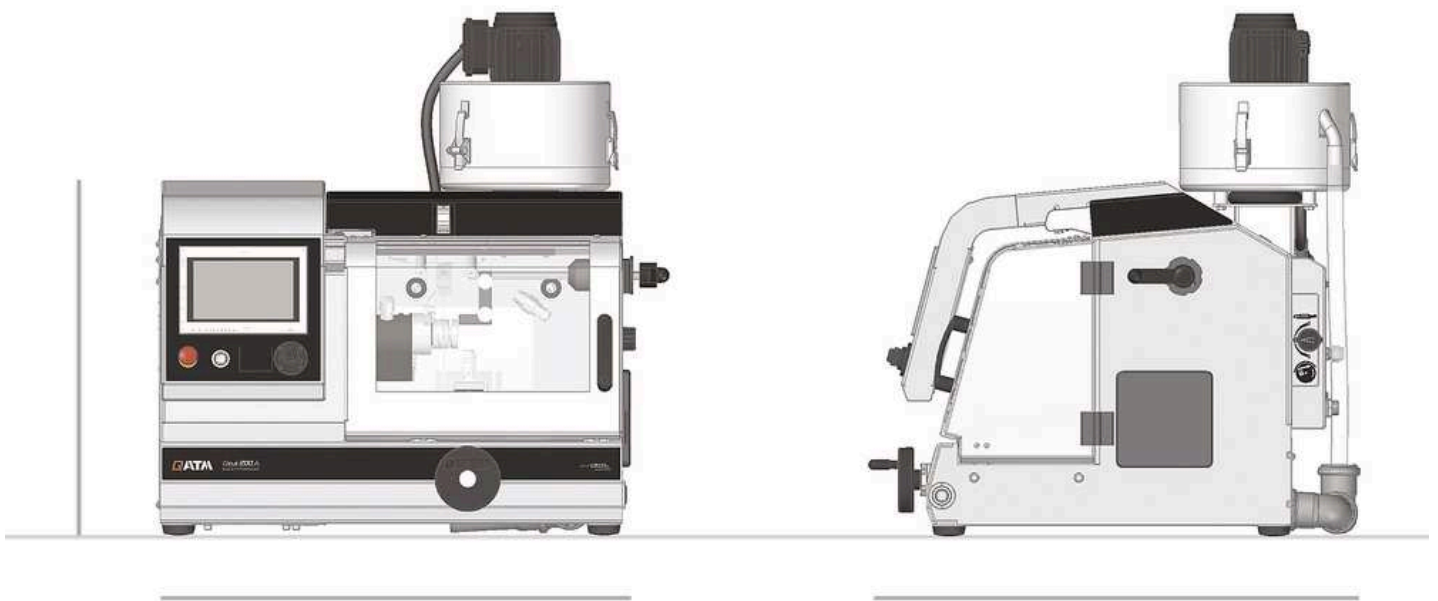

<b>Slijpschijf</b>	up to $\varnothing$ 203 mm / 8"
<b>Max. cutting capacity</b>	75 mm (cut-off wheel $\varnothing$ 200 mm)
<b>Afmeting flens voor slijpschijf</b>	$\varnothing$ 12,7 mm
<b>X-axis</b>	210 mm (manual / automatic)
<b>Y-axis</b>	80 mm (automatic)
<b>Z-axis (option)</b>	80 mm (automatic)
<b>Feedrate</b>	0.01 - 20 mm/s
<b>Precisie Z-as</b>	0,005 mm
<b>min. cross feed (Z-axis)</b>	0,001 mm
<b>Tafel zonder Z-as (BxD)</b>	300 x 210 mm
<b>Tafel met Z-as (BxD)</b>	280 x 210 mm
<b>T-slot</b>	8 mm

<b>Snelheid</b>	300 - 5000 rpm
<b>Vermogen aanrijving (hoofdaandrijving)</b>	0,75 kW, S1
<b>Aansluitvermogen</b>	2,2 kVA
<b>B x H x D</b>	725 x 535 x 675 mm
<b>Gewicht</b>	~ 82 kg

[www.qatm.com/qcut-200-a](http://www.qatm.com/qcut-200-a)

## BESTELGEGEVENS

### BASIS UITRUSTING

#### MACHINE (1 ITEM NOODZAKELIJK)

M1891000  Qcut 200 A Base machine 200-240V, 50/60Hz

M1891001  Qcut 200 A Base machine 100-120V, 50/60Hz

#### CROSS FEED (1 ITEM REQUIRED)

A1891000 Qcut 200 A automatic X, Y axis

A1891001 Qcut 200 A automatic X, Y, Z axis

### OPTIONS (TO BE ORDERED WITH MACHINE)

A1891003 Qcut 200 A cutting chamber cleaning

A1891004 Qcut 200 A flow monitoring

A1891005 Qcut 200 A preparation rotation device

Z1891000 Qcut 200 A dressing device

A1891008 Preparation centrifugal separator

Z1891006 Centrifugal separator

A1891002 Preparation fresh water cooling system

#### RECIRCULATION SYSTEM (1 ITEM REQUIRED)

Z5800011 Qcut 200 A recirculation cooling system 15 Ltr.

Z5800012 Qcut 200 A recirculation cooling system 45 Ltr., mobile

Z5800013 Qcut 200 A recirculation cooling system 45 Ltr., for system lab

Z5800014 Pump module recirculation cooling

Z5800015 Pump module chamber cleaning (not usable with cooling system 15 Ltr.)

### OPTIES (KUNNEN AFZONDERLIJK BESTELD WORDEN)

Z1800002



Sample collector

Z1891001      Rotation device type RD2.1

Z1870050      Flange set Ø 59 mm

Z1870051      Flange set Ø 99 mm

Z1870052      Flange set Ø 139 mm

## PRECISION CLAMPING DEVICES, CLAMPING\_DEVICES, PRECISION\_CLAMPING\_DEVICES

Z1870035      Sample holder L standard Ø 40 mm open, Clamping\_devices,  
Precision\_clamping\_devices

Z1870037      Sample holder L standard Ø 40 mm closed, Clamping\_devices,  
Precision\_clamping\_devices

Z1870039      Sample holder L Flex Ø 40 mm, Clamping\_devices, Precision\_clamping\_devices

Z1870043      Sample holder L parallel clamping vice open, Clamping\_devices,  
Precision\_clamping\_devices

Z1870041      Sample holder L parallel clamping vice closed, Clamping\_devices,  
Precision\_clamping\_devices

Z1870045      Drop shape sample holder L Ø 40 mm, Clamping\_devices,  
Precision\_clamping\_devices

Z1870047      Universal clamping vice L, Clamping\_devices, Precision\_clamping\_devices

Z1870054      Mini vice L, Clamping\_devices, Precision\_clamping\_devices

Z1870056      Double parallel vice L, Clamping\_devices, Precision\_clamping\_devices

Z1870058      Adaptor with ball joint L, Clamping\_devices, Precision\_clamping\_devices

Z1870064      Reduction ring Ø 25 mm, Clamping\_devices, Precision\_clamping\_devices

Z1870063      Reduction ring Ø 30 mm, Clamping\_devices, Precision\_clamping\_devices

Z1870071      Reduction ring Ø 40 mm, Clamping\_devices, Precision\_clamping\_devices

Z1870067      Reduction ring 1", Clamping\_devices, Precision\_clamping\_devices

Z1870066      Reduction ring 1 1/4", Clamping\_devices, Precision\_clamping\_devices

Z1870065      Reduction ring 1 1/2", Clamping\_devices, Precision\_clamping\_devices

Z1870068      Manual chuck Ø 32 mm, Clamping\_devices, Precision\_clamping\_devices

Z1870069      Manual chuck Ø 44 mm, Clamping\_devices, Precision\_clamping\_devices

Z1870070 Manual chuck Ø 56 mm, Clamping\_devices, Precision\_clamping\_devices

#### VACUUM CLAMPING VICES, CLAMPING\_DEVICES, PRECISION\_CLAMPING\_DEVICES

Z1870028 Vacuum sample holder, Clamping\_devices, Precision\_clamping\_devices

01870288 Vacuum holder (sacrificial plate), Clamping\_devices, Precision\_clamping\_devices

Z1304600 Vacuum pump 230V/50Hz for vacuum sample holder, Clamping\_devices, Precision\_clamping\_devices

Z1304634 Vacuum pump 110V/60Hz for vacuum sample holder, Clamping\_devices, Precision\_clamping\_devices

## QUICK CLAMPING TOOLS, CLAMPING\_DEVICES

#### QTOOL 40, CLAMPING\_DEVICES, QTOOL\_SERIES

Z2270201 Qtool 40 S, Clamping\_devices, Qtool\_series

Z2270200 Qtool 40, Clamping\_devices, Qtool\_series

02270202 Clamping jaw 25 mm - for Qtool 40, Clamping\_devices, Qtool\_series

Z2270202 Clamping jaws 45 mm - for Qtool 40, Clamping\_devices, Qtool\_series

02270212 Clamping jaw 25 mm bevelled - for Qtool 40, Clamping\_devices, Qtool\_series

02270213 Clamping jaw 25 mm cross prism - for Qtool 40, Clamping\_devices, Qtool\_series

Z2270203 Clamping jaws 45 mm slotted - for Qtool 40, Clamping\_devices, Qtool\_series

Z2270204 Clamping jaws 45 mm slotted prism - for Qtool 40, Clamping\_devices, Qtool\_series

#### QTOOL 60, CLAMPING\_DEVICES, QTOOL\_SERIES

Z2235200 Qtool 60, Clamping\_devices, Qtool\_series

02235202 Clamping jaw 32 mm - for Qtool 60, Clamping\_devices, Qtool\_series

Z2235201 Clamping jaws 60 mm - for Qtool 60, Clamping\_devices, Qtool\_series

02235212 Clamping jaw 32 mm bevelled - for Qtool 60, Clamping\_devices, Qtool\_series

02235213 Clamping jaw 32 mm cross prism - for Qtool 60, Clamping\_devices, Qtool\_series

Z2235202 Clamping jaws 60 mm slotted - for Qtool 60, Clamping\_devices, Qtool\_series

Z2235203 Clamping jaws 60 mm slotted prism - for Qtool 60, Clamping\_devices, Qtool\_series

## EASY-CLAMPING PLATES, CLAMPING\_DEVICES,

## EASY\_CLAMPING\_PLATES

Z2236030	Easy-clamping plate S, Clamping_devices, Easy_clamping_plates
Z2236031	Easy-clamping plate S with rotating unit, Clamping_devices, Easy_clamping_plates
Z2236035	Easy-clamping plate M, Clamping_devices, Easy_clamping_plates

## ACCESSORIES FOR EASY-CLAMPING PLATES



Z2236032	Easy adaption horizontal, Clamping_devices, Easy_clamping_plates
Z2236033	Easy adaption vertical, Clamping_devices, Easy_clamping_plates
Z2236034	Easy adaption Qtool 40 - 60, Clamping_devices, Easy_clamping_plates
Z2236038	Multitower rotating plate, Clamping_devices, Easy_clamping_plates
Z2236039	Multitower, Clamping_devices, Easy_clamping_plates
Z2236040	Swivel unit Qtool 40 - 60, Clamping_devices, Easy_clamping_plates
Z2236036	Easy-multifunctional plate, Clamping_devices, Easy_clamping_plates

## CLAMPING ACCESSORIES FOR ROTATING, SWIVELING AND SPECIAL APPLICATIONS, CLAMPING\_DEVICES, CLAMPING\_ACCESSORIES\_SPECIALS

Z1304643	Screw clamber with Easy-clamping plate M, Clamping_devices, Clamping_accessories_specials
Z1304636	Expansion clamping device, Clamping_devices, Clamping_accessories_specials
Z2236009	Vertical clamp single, Clamping_devices, Clamping_accessories_specials
Z2236010	Vertical clamp double, Clamping_devices, Clamping_accessories_specials
Z2234010	Clamping system X-Clamp 3858, Clamping_devices, Clamping_accessories_specials

## UNIVERSAL VICES AND ACCESSORIES, CLAMPING\_DEVICES, UNIVERSAL\_VICES\_AND\_ACCESSORIES

01350022	Prism 120°, Clamping_devices, Universal_vices_and_accessories
01350023	Prism slim, Clamping_devices, Universal_vices_and_accessories
01350024	Prism 90°, Clamping_devices, Universal_vices_and_accessories

Z1350008		Universal vice Piccolo 54, Clamping_devices, Universal_vices_and_accessories
Z1350010		Suitcase set universal vice Piccolo 54, Clamping_devices, Universal_vices_and_accessories
Z1350012		Universal vice Piccolo 100, Clamping_devices, Universal_vices_and_accessories
92005796		Longitudinal v-shoe, Clamping_devices, Universal_vices_and_accessories
92005797		Traverse v-shoe, Clamping_devices, Universal_vices_and_accessories
92005799		Longitudinal bridge, Clamping_devices, Universal_vices_and_accessories
92005800		Traverse bridge, Clamping_devices, Universal_vices_and_accessories
92005798		Standard clamping shoe, Clamping_devices, Universal_vices_and_accessories
Z1350007		Height adapter 60mm Piccolo, Clamping_devices, Universal_vices_and_accessories
Z1350003		Height adapter 74mm Mono, Clamping_devices, Universal_vices_and_accessories
95003172		Clamping arm extension Piccolo 54 and Mono 61, Clamping_devices, Universal_vices_and_accessories
Z1304591		Fixing screw M6 x 25, Clamping_devices, Universal_vices_and_accessories
95003169		Fixing screw Piccolo M8 x 25, Clamping_devices, Universal_vices_and_accessories
95003170		Fixing screw Piccolo M10 x 25, Clamping_devices, Universal_vices_and_accessories
95003168		Fixing screw Mono M10 x 32, Clamping_devices, Universal_vices_and_accessories
91001157		T-slot nut - stainless M6 x 8, Clamping_devices, Universal_vices_and_accessories
91001161		T-slot nut - stainless M8 x 10, Clamping_devices, Universal_vices_and_accessories
91001159		T-slot nut - stainless M8 x 12, Clamping_devices, Universal_vices_and_accessories
91001158		T-slot nut - stainless M10 x 12, Clamping_devices, Universal_vices_and_accessories